

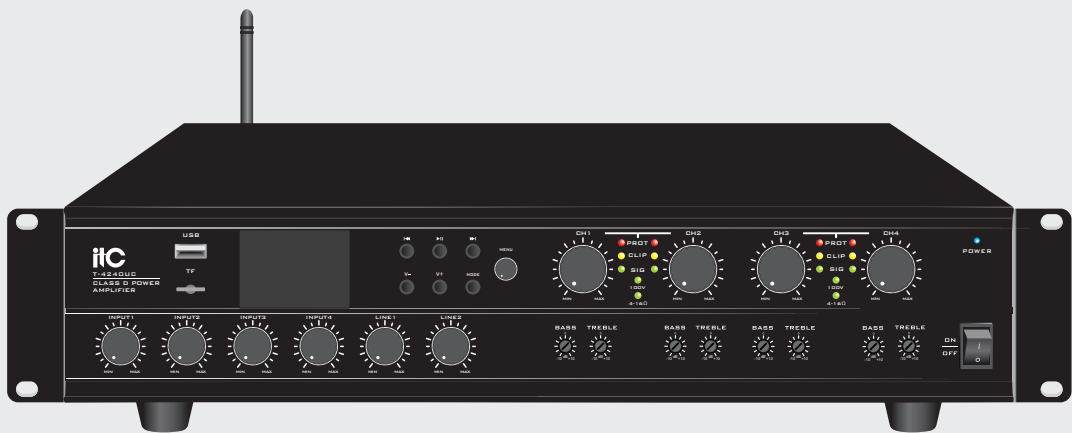

PUBLIC ADDRESS SYSTEM

OPERATION MANUAL

T-4120UC/T-4240UC CLASS D POWER AMPLIFIER



Please follow the instructions in this manual to obtain the optimum results from this unit. We also recommend that you keep this manual handy for future reference.

TABLE OF CONTENTS

1. SAFETY PRECAUTIONS	3
2. GENERAL DESCRIPTION	5
3. FEATURES	5
4. NOMENCLATURE AND FUNCTIONS	
4.1 Front Panel	6
4.2 Rear Panel.....	7
5. OPERATION ILLUSTRATION	8
6. SCREEN OPERATION INSTRUCTIONS	11
7. TROUBLESHOOTING	15
8. APPLICATIONS	16
9.BLOCK DIAGRAM	17
10.SPECIFICATIONS	18
11.DIMENSIONAL DIAGRAM	19

1. SAFETY PRECAUTIONS

- Be sure to read the instructions in this section carefully before use.
- Make sure to observe the instructions in this manual as the conventions of safety symbols and messages regarded as very important precautions are included.
- We also recommend you keep this instruction manual handy for future reference.

Safety Symbol and Message Conventions

Safety symbols and messages described below are used in this manual to prevent bodily injury and property damage which could result from mishandling. Before operating your product, read this manual first and understand the safety symbols and messages so you are thoroughly aware of the potential safety



WARNING

Indicates a potentially hazardous situation which, if mishandled, could result in death or serious personal injury.



CAUTION

Indicates a potentially hazardous situation which, if mishandled, could result in moderate or minor personal injury, and/or property damage.



WARNING

When Installing the Unit

- Do not expose the unit to rain or an environment where it may be splashed by water or other liquids, as doing so may result in fire or electric shock.
- Use the unit only with the voltage specified on the unit. Using a voltage higher than that which is specified may result in fire or electric shock.
- Do not cut, kink, otherwise damage nor modify the power supply cord. In addition, avoid using the power cord in close proximity to heaters, and never place heavy objects -- including the unit itself -- on the power cord, as doing so may result in fire or electric shock.
- Be sure to replace the unit's terminal cover after connection completion. Because high voltage is applied to the speaker terminals, never touch these terminals to avoid electric shock.
- Be sure to ground to the safety ground (earth) terminal to avoid electric shock. Never ground to a gas pipe as a catastrophic disaster may result.
- Avoid installing or mounting the unit in unstable locations, such as on a rickety table or a slanted surface. Doing so may result in the unit falling down, causing personal injury and/or property damage.

When the Unit is in Use

- Should the following irregularity be found during use, immediately switch off the power, disconnect the power supply plug from the AC outlet and contact your nearest **ITC** dealer. Make no further attempt to operate the unit in this condition as this may cause fire or electric shock.
 - If you detect smoke or a strange smell coming from the unit.
 - If water or any metallic object gets into the unit
 - If the unit falls, or the unit case breaks
 - If the power supply cord is damaged (exposure of the core, disconnection, etc.)
 - If it is malfunctioning (no tone sounds.)
- To prevent a fire or electric shock, never open nor remove the unit case as there are high voltage components inside the unit. Refer all servicing to your nearest **ITC** dealer.
- Do not place cups, bowls, or other containers of liquid or metallic objects on top of the unit. If they accidentally spill into the unit, this may cause a fire or electric shock.
- Do not insert nor drop metallic objects or flammable materials in the ventilation slots of the unit's cover, as this may result in fire or electric shock.

CAUTION

When Installing the Unit

- Never plug in nor remove the power supply plug with wet hands, as doing so may cause electric shock.
- When unplugging the power supply cord, be sure to grasp the power supply plug; never pull on the cord itself. Operating the unit with a damaged power supply cord may cause a fire or electric shock.
- When moving the unit, be sure to remove its power supply cord from the wall outlet. Moving the unit with the power cord connected to the outlet may cause damage to the power cord, resulting in fire or electric shock. When removing the power cord, be sure to hold its plug to pull.
- Do not block the ventilation slots in the unit's cover. Doing so may cause heat to build up inside the unit and result in fire.
- Avoid installing the unit in humid or dusty locations, in locations exposed to the direct sunlight, near the heaters, or in locations generating sooty smoke or steam as doing otherwise may result in fire or electric shock.

When the Unit is in Use

- Do not place heavy objects on the unit as this may cause it to fall or break which may result in personal injury and/or property damage. In addition, the object itself may fall off and cause injury and/or damage.
- Make sure that the volume control is set to minimum position before power is switched on. Loud noise produced at high volume when power is switched on can impair hearing.
- Do not operate the unit for an extended period of time with the sound distorting. This is an indication of a malfunction, which in turn can cause heat to generate and result in a fire.
- Contact your **ITC** dealer as to the cleaning. If dust is allowed to accumulate in the unit over a long period of time, a fire or damage to the unit may result.
- If dust accumulates on the power supply plug or in the wall AC outlet, a fire may result. Clean it periodically. In addition, insert the plug in the wall outlet securely.
- Switch off the power, and unplug the power supply plug from the AC outlet for safety purposes when cleaning or leaving the unit unused for 10 days or more. Doing otherwise may cause a fire or electric shock.

An all-pole mains switch with a contact separation of at least 3 mm in each pole shall be incorporated in the electrical installation of the building.

Due to product upgrades, while some of the features and specification in the user manual does not match the actual functions, sorry for any inconvenience and thanks for your kind understanding!

2. GENERAL DESCRIPTION

The new UC series of digital mixer amplifiers are more efficient and a cost-effective solution specially developed to meet the needs of the global market. It is suitable for commercial audio installations. Just to meet the needs of emerging markets to provide high-quality equipment at an affordable price, the UC series mixer amplifiers are equipped with 4R and 100V two-way outputs and a series of convenient functions, which are flexible and applicable worldwide. The series combines many convenient and flexible functions, including Bluetooth and USB media player; low impedance function (4ohm/8ohm) and high impedance output (100V); each output channel is equipped with a separate bass and treble control.

3. FEATURES

1. 4 channels output, 120W/240W constant impedance or constant voltage high performance digital mixer amplifier (4-16R/100V).
2. Built-in MP3 recording function.
3. 6-channel independent volume control.
4. The 6-channel audio source can be configured as a matrix to each channel output.
5. INPUT1-4 input with adjustable gain control.
6. The 4 outputs are with independent volume control.
7. Remote microphone input, max can be 4 remote microphones.
8. Built-in MP3 (U disk/SD card) player function.
9. Built-in FM radio function.
10. With high-end TFT display.
11. 4 outputs can remotely control the panel to adjust the circuit.
12. There are distortion, protection, signal, output status indicators.
13. INPUT1-4 channels can be configured with phantom power.
14. INPUT1-4 channels have priority and mixing selection function.
15. Priority input port for EMC alarm.
16. ALARM interface plays the specified alarm music.
17. Built-in Bluetooth function, can be connected to mobile phone/computer, with external high-gain Bluetooth antenna.
18. 4 mute interfaces can be connected to the fire control interface.
19. Priority: EMC >MUTE >REMOTE MIC >INPUT1-4 >LINE1-2.

4. NOMENCLATURE AND FUNCTIONS

4.1 FRONT PANEL

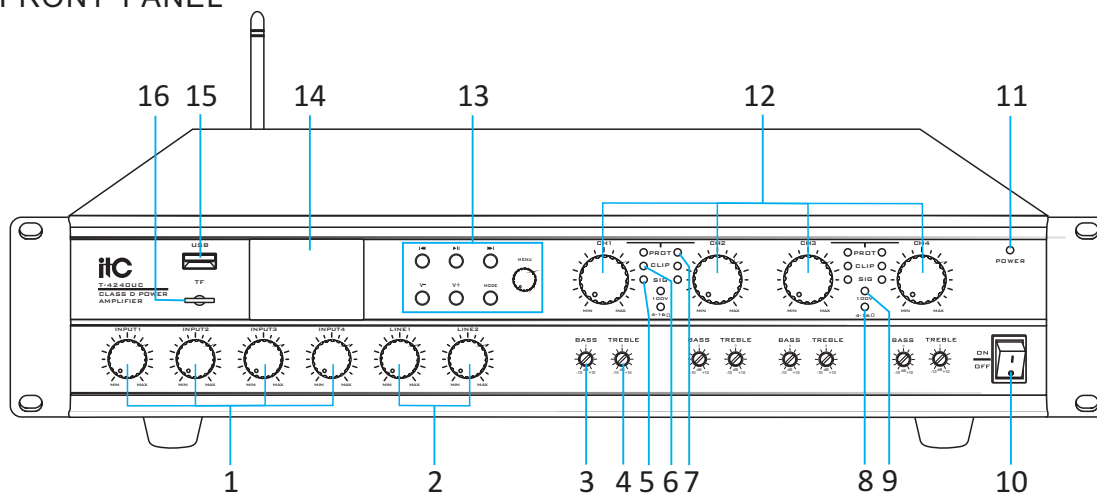

1. INPUT 1-4 channel volume control, the potentiometer controls the input level. When the potentiometer is turned clockwise, the volume will gradually increase, and the reverse rotation will gradually decrease the volume.
2. LINE1/LINE2 input channel volume control.
3. BASS—bass knob of main channel.
4. TREBLE—treble knob of main channel.
5. SIG—signal indicator, when there is music signal input, as the volume potentiometer is turned on, this signal indicator lights up; the brightness changes with the size of the input music signal.
6. CLP—Clip indicator. When the indicator on the machine is lit by signal, the output signal has been distorted at this time, indicating that the input signal is too large. Please reduce the input signal.
7. PROT—This indicator light is on when the machine protection function is activated. If the speaker wire is short-circuited, or the power of the connected speakers is 1.5 times greater than the rated power, the protection circuit inside the machine will work, and the power amplifier output will be disconnected and the protection indicator light will light up (the signal indicator is only used to indicate the input music signal, when in the protection state, the signal indicator still lights up according to the size of the input signal). When the machine is working normally, this indicator is off.
8. 4~16Ω—constant impedance 4~16Ω mode status indicator.
9. 100V—constant voltage 100V mode status indicator.
10. ON/OFF—Power switch, press the switch up to turn on the power; press the switch down to turn off the power.
11. POWER—power indicator light. When the power is turned on, the power indicator light is on, indicating that the machine is in working condition. When the power is off (shutdown), the power indicator goes out.
12. Main channel CH1-CH4 volume control.
13. Operation button area
14. 2.4-inch color screen, used to display the current working status of the machine;
15. USB interface.
16. TF socket.

4. NOMENCLATURE AND FUNCTIONS

4.2 REAR PANEL

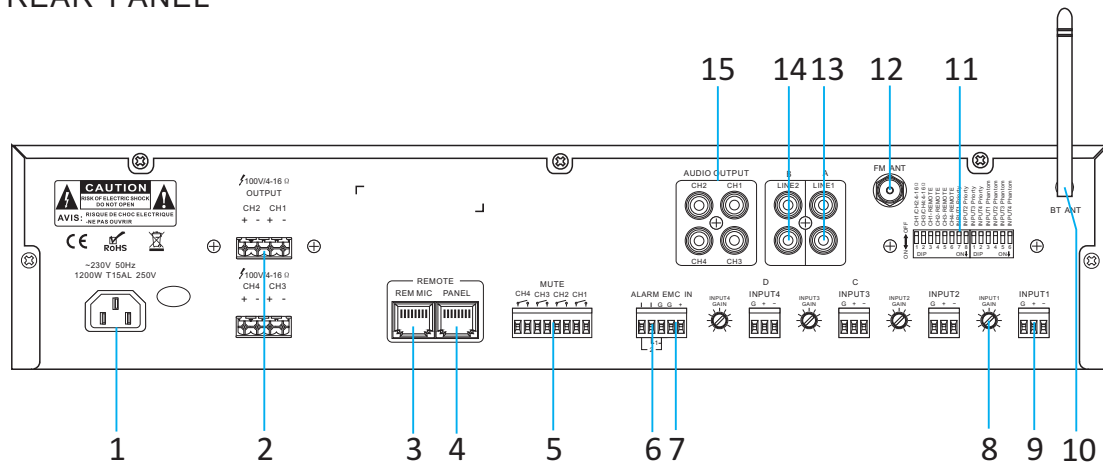

1. AC input socket.
2. CH1/CH2/CH3/CH4 audio output port.
3. REM MIC input network port.
4. PANEL access network port.
5. MUTE trigger port.
6. ALARM1, ALARM2 trigger port.
7. EMC input port.
8. GAIN adjustment potentiometer of input channel.
9. INPUT balanced input interface.
10. Bluetooth antenna.
11. Function dial switch.
12. FM antenna interface.
13. LINE1 input interface.
14. LINE2 input interface.
15. AUDIO OUTPUT interface.

5. OPERATION ILLUSTRATION

1. Operation button description

The button area is shown on the right. The "MENU" knob can be rotated clockwise or counterclockwise to move the interface cursor and select the specified function. Short press the "MENU" knob to confirm the operation. The "MODE" button is dedicated to switching multimedia functions: Music Center, FM radio, Recording, Bluetooth.

- | | |
|-----------------------|-----------------------|
| 1. Play/Pause button | 2. Next song button |
| 3. "MENU" knob button | 4. "MODE" mode button |
| 5. Volume + button | 6. Volume - button |
| 7. Last song button | |

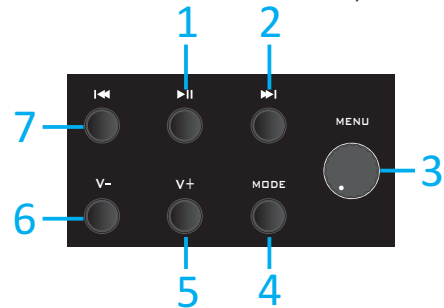

Special function operation instructions:

① Update resource library and firmware with TF card inside the device

Put the resource library and firmware files into the root directory of the TF card and insert it into the built-in TF card socket, when the device is off, press and hold the "MENU" knob to turn it on, after seeing the screen light up and displaying information, release the button to automatically update the firmware and resource library.

② Update the system Bootloader

Put the system Bootloader file into the root directory of the TF card and insert it into the built-in TF card socket, when the device is off, press and hold the "Play/Pause" button to turn it on, after seeing the screen light up and displaying information, release the button to automatically update the firmware and resource Library.

2. Volume Control

The master volume control is shown below, CH1 and CH2 share the same constant pressure/constant impedance indicator light, CH3 and CH4 share the same constant voltage/constant impedance indicator light.

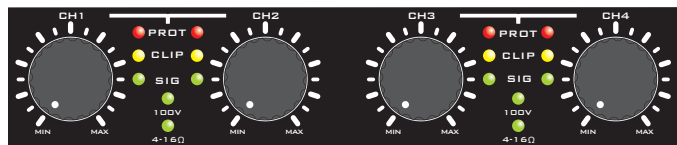

3. Treble and bass control

The treble and bass control are shown below. The maximum adjustable of BASS or TREBLE is $\pm 10\text{dB}$.



4. Dial Function Description

The enlarged view of the DIP switch is shown on the right, it can be used to configure specific functions. Specific functions include configuration of constant voltage/constant impedance mode, local/remote volume control, INPUTx priority control, and INPUTx Phantom function disable/enable.

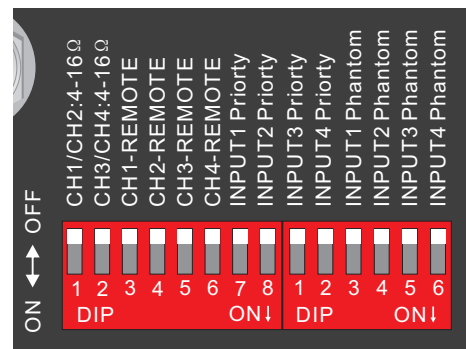

5. OPERATION ILLUSTRATION

Local/remote volume control

Local volume control: Turn the switch corresponding to CH1-REMOTE to OFF, and the other channels are the same.

Remote volume control: Turn the switch corresponding to CH1-REMOTE to ON, and the other channels are the same.

INPUTx priority control

INPUTx normal priority: Turn the switch corresponding to INPUTx Priority to OFF.

INPUTx high priority: Turn the switch corresponding to INPUTx Priority to ON.

Description:

When INPUTx is set to high priority, the priority of INPUTx is higher than that of LINE1 and LINE2. It means once the matrix switch between INPUTx and output channel CHx is turned on, the matrix switch between LINE1, LINE2 and output channel CHx will be automatically turned off, regardless of whether the switch between LINE1, LINE2 and CHx is turned on. When INPUTx is set to normal priority, INPUTx and LINEx have the same priority.

Phantom function

Turn on the Phantom function: Turn the dial switch corresponding to INPUTx Phantom to ON.

Turn off the Phantom function: Turn the dial switch corresponding to INPUTx Phantom to OFF.

5. Description of ALARM and EMC IN

The ALARM and EMC IN trigger and input interfaces are shown in the figure above. For EMC trigger, you only need to input audio to the EMC IN interface to trigger. When triggered, the home page of the screen interface will display: "EMC audio input".

Before using the ALARM function, you need to insert a TF card in the front panel, and put the alarm audio file in the specified folder of the TF card. The specific folder is named

ALARM1 corresponding folder: `_ALARM1_FOLDER`

ALARM2 corresponding folder: `_ALARM2_FOLDER`

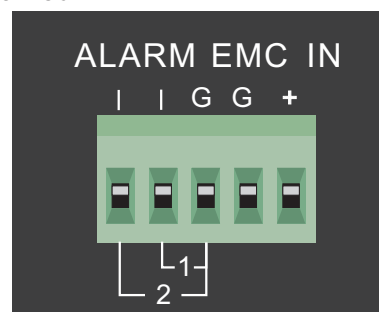

Note:

The folder must be placed in the root directory of the TF card. Each alarm audio folder can only contain one audio file. If multiple audio files are placed, only one can be recognized. When an alarm is triggered, the audio file under the corresponding file will be played cyclically, and the screen interface will automatically jump to the home page, and the alarm information will be displayed below.

6. MUTE description

The MUTE trigger port is shown in the figure above. To mute a channel, just short-circuit the port in the figure, but note that the corresponding channel will not be muted when EMC is triggered.

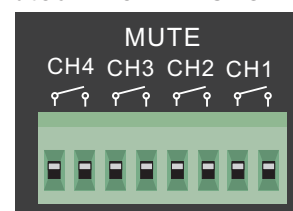

5. OPERATION ILLUSTRATION

7. Speaker Connection

Before turning on the device, please carefully confirm that the load is constant-voltage or constant-impedance speakers and set the amplifier to the corresponding output mode. It is forbidden to switch the constant voltage and constant impedance state arbitrarily when the power is on.

Constant voltage mode: Turn the switches corresponding to CH1/CH2: 4-16Ω and CH3/CH4: 4-16Ω to OFF.

Constant impedance mode: Turn the switches corresponding to CH1/CH2: 4-16Ω and CH3/CH4: 4-16Ω to ON.

The operation method is as follows:

①When the 100V and 4-16Ω speaker output mode selection switch is set to the 100V position, as shown in the figure below:

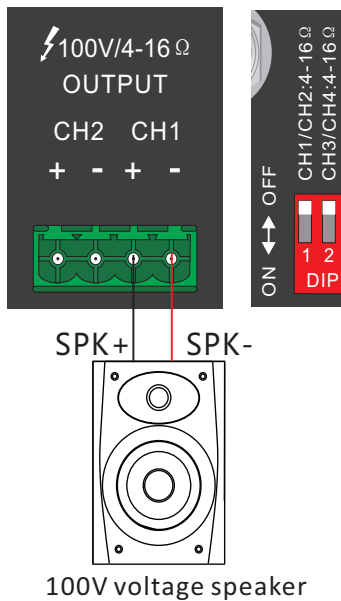

②When the 100V and 4-16Ω speaker output mode selection switch is set to the 4-16Ω position, as shown in the figure below:

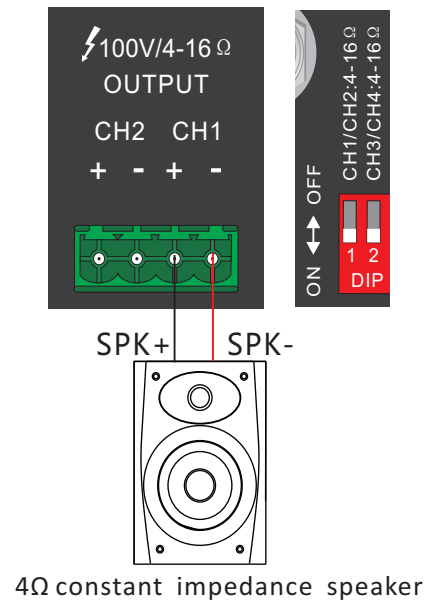

8. Audio source priority

EMC > MUTE > REMOTE MIC > INPUT1-4 > LINE1-2.

6. SCREEN OPERATION INSTRUCTIONS

1. Home

The homepage is mainly composed of the three function icons of "Audio matrix", "Multimedia" and "Volume" and the status area below, which will display different status information in different states. On the home page, you can use the "MENU" knob to switch the cursor to select a function, and short press the "MENU" knob to enter that function. On the home page, you can also use the "MODE" button to switch the multimedia function mode (except for the recording mode). The recording mode can be switched by the "MODE" button on the multimedia interface, or switch to this mode by default when both the U disk and TF card are removed.

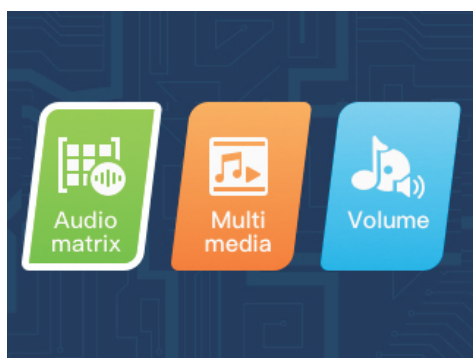

Left: no status display

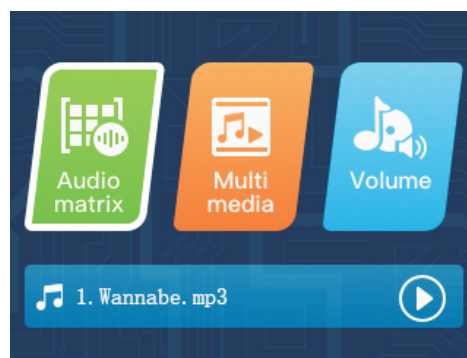

Right: status display

2. Audio matrix

The audio matrix interface is used to configure the switch of each channel of the audio matrix, as shown in the figure below, you can use the "MENU" knob to switch the cursor to select the channel to be configured, and then short press the "MENU" knob to switch the state "ON" or "OFF", one output channel CHx allows up to 4 input channels to be connected simultaneously.

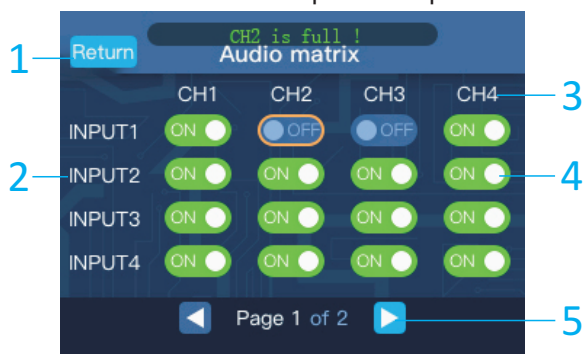

Left: Audio matrix page 1



Right: Audio matrix page 2

1. Return button;
2. Input channel;
3. Output channel;
4. Channel switch status: "ON" or "OFF";
5. Page number information and page turn button.

3. Multimedia

3.1 Music center

The interface of the music center is shown below:

1. Return button;
2. TF mode indication, when it is not highlighted, it means it is not TF mode;
3. Volume;
4. The total number of recognizable songs on the media USB or TF;
5. Play progress bar;

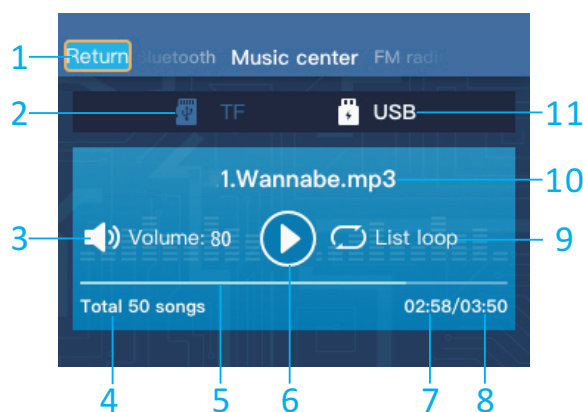

6. SCREEN OPERATION INSTRUCTIONS

6. Play/Pause button;
7. Play time;
8. Song duration;
9. Play mode (List loop, Single cycle, Order playback, Single playback);
10. Song number and song file name;
11. USB mode indication, when highlighted, it means it is in USB mode.

Play control

Control play/pause, last/next song, volume increase and decrease through the button area on the machine panel. In addition, the "MENU" knob can be used to control play/pause.

Play mode switch

Use the "MENU" knob to select the one indicated by the number 9 in the figure, short press the "MENU" knob to cycle through the 4 playback modes: List loop, Single cycle, Order playback and Single playback.

Play media switching

Use the "MENU" knob to select "TF" or "USB", and short press the "MENU" knob to switch to the "TF" or "USB" mode. Of course, if the "TF" or "USB" is not inserted, the switch cannot be successful.

3.2 FM radio

The FM interface is shown in the figure below, which can display basic information such as channel number, channel frequency, playback status, and volume, specific:

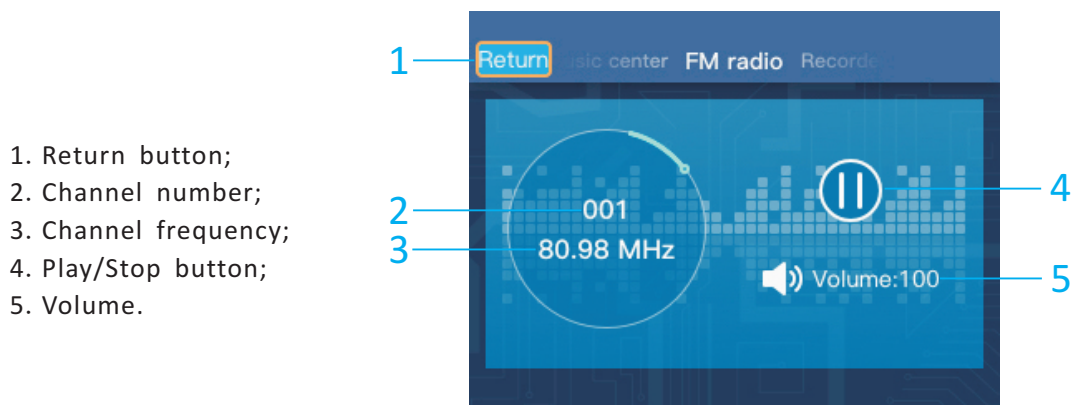

FM radio

In addition, long press the play/pause button to perform a re-searching operation. As shown in the figure below, "Searching" will be displayed in front of the channel number, indicating that the channel is searching. After the search is completed, the display screen will automatically remove the "Searching" letter display.

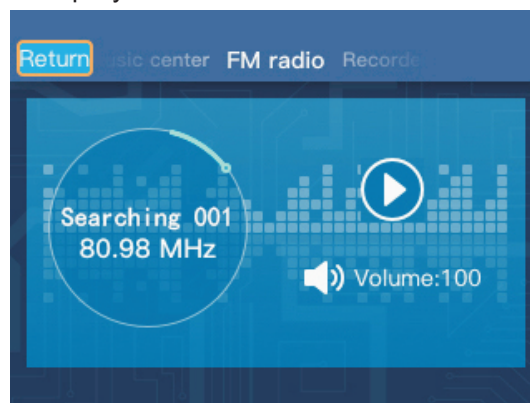

FM in searching

6. SCREEN OPERATION INSTRUCTIONS

3.3 Recorder

The audio recorder interface is shown in the figure below. It can be used to record the audio of some audio input channels and store it in the form of MP3 files to USB or TF.

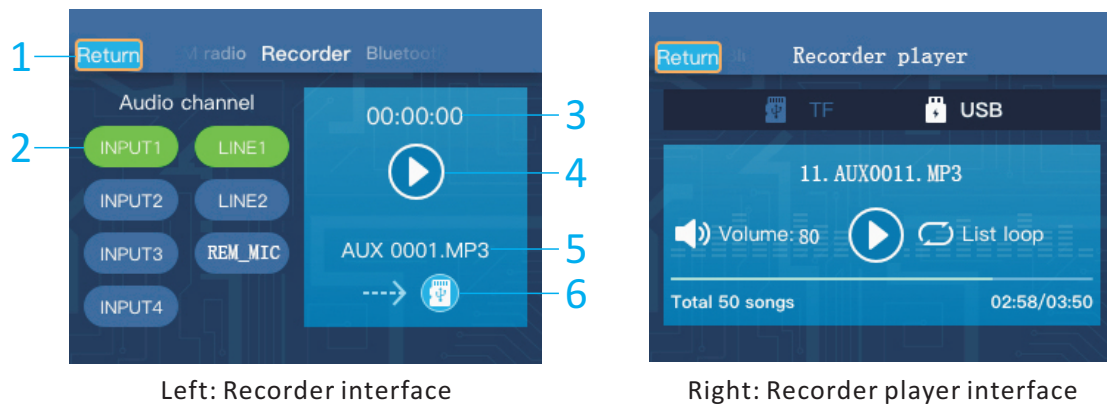

1. Return button;
2. Audio channel, can select some channels for recording;
3. Recording time;
4. Start/End recording button;
5. Recording storage file name;
6. Storage medium type: TF or USB.

Start recording

Short press the “Play/Pause” button or turn the “MENU” knob to switch the cursor to the Start/End recording button (label 4 in the figure) to start or end recording. After recording is turned on, the audio matrix will open the selected audio channel and output, and the unselected channel will be closed.

End recording

After finishing recording, it will automatically jump to the recorder player interface (as shown) to play the audio just recorded, and automatically turn on the Multimedia input channel and CHx channel switch configured in the audio matrix interface.

Recorder player

To enter the recorder player interface, in addition to automatically entering when ending recording, you can also long press the “Last song” or “Next song” button to enter the recorder player interface when recording is not started.

In the recorder player interface, “Recorder player” will be additionally displayed in green below to indicate that this is not a music center, but a recording file playback interface. In this interface, the audio matrix will only turn on the Multimedia input channel and CHx channel switch configured in the “Audio matrix” interface, and other channels will be turned off.

To exit the recorder player interface, press the label 1 (Return button) to directly return to the recorder interface, or press the “MODE” button to return to the recorder interface and restore the audio matrix switch state.

6. SCREEN OPERATION INSTRUCTIONS

3.4 Bluetooth

The Bluetooth interface is shown in the figure below, which can display the Bluetooth connection status and volume value.

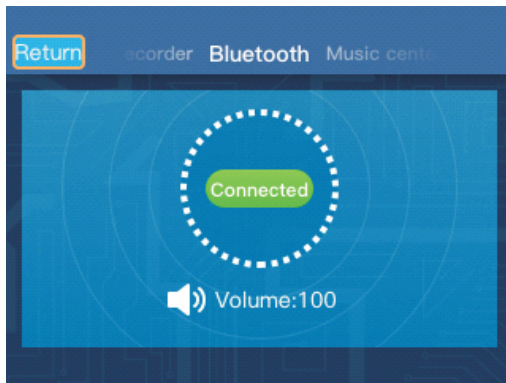

Left: Bluetooth is connected

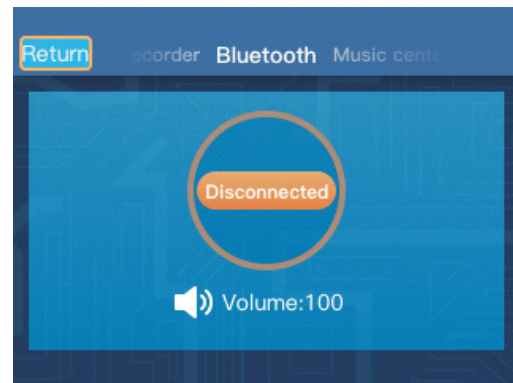

Right: Bluetooth is disconnected

4. Volume

The volume interface is shown in the figure below, which displays the CHx volume value of the main output channel, remote or local control volume, and the online and offline status of remote audio control equipment.

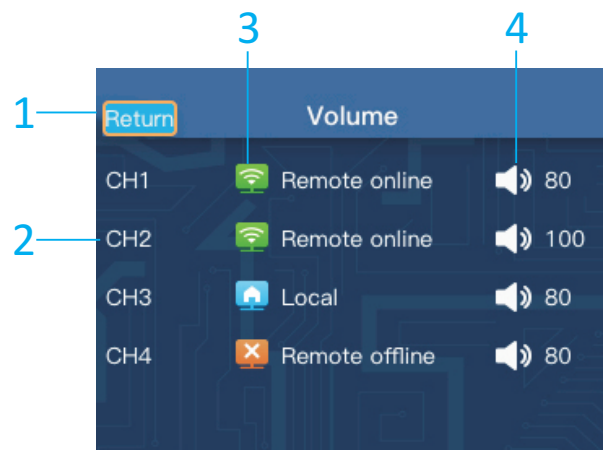

1. Return button
2. Output channel CHx
3. Volume control status: local, remote online, remote offline
4. Volume value, indicating the volume value of the local volume control or remote audio control equipment.

When the volume control status is “Local” or “Remote offline”, the volume is controlled by the host volume knob; when the volume control status is “Remote online”, the volume is controlled by the remote audio control equipment.

7. TROUBLESHOOTING

Failure phenomena	Failure cause
1. Power switch is not opened	<ol style="list-style-type: none">1. Power line is cut off2. The protection function of the equipment is not activated
2. All lines are connected, but there is no sound.	<ol style="list-style-type: none">1. The power switch is not opened or the power plug is bad contacted.2. The fuse is burnt3. The volume knob is not opened or turned down to a extra low level4. There is no audio signal input5. There is short-circuit in the speaker line.
3. The sound suddenly disappears in normal status.	<ol style="list-style-type: none">1. The equipment is in very high temperature to make it into protection status.2. The connection wire is bad contact.
4. Low sound	The equipment is set to be low impedance connection, but the speakers connected is with high impedance.
5. Sound is distorted	The input level of Mic or external equipment is too high

8. APPLICATIONS

REAR PANEL CONNECTIONS

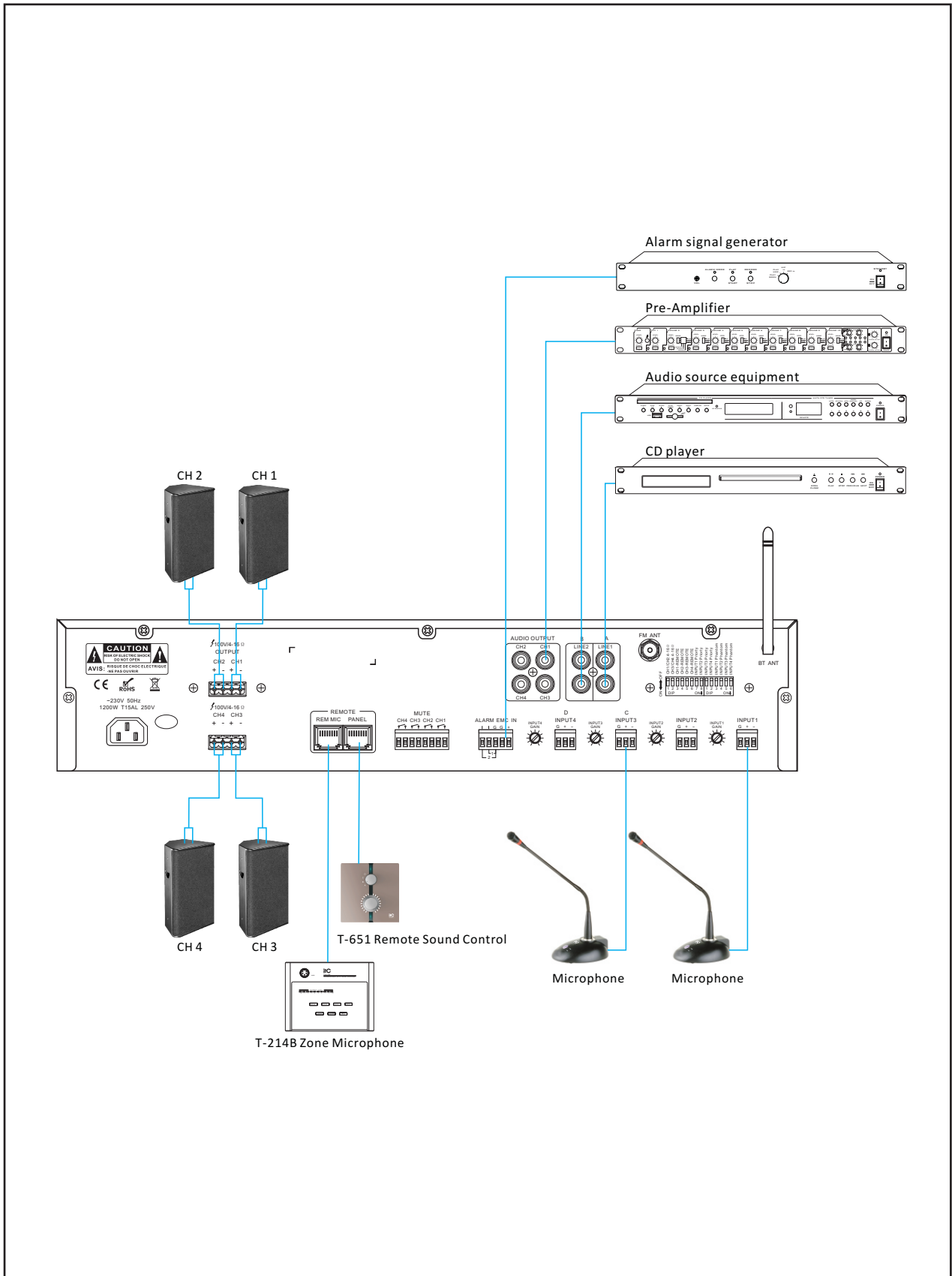

9. BLOCK DIAGRAM

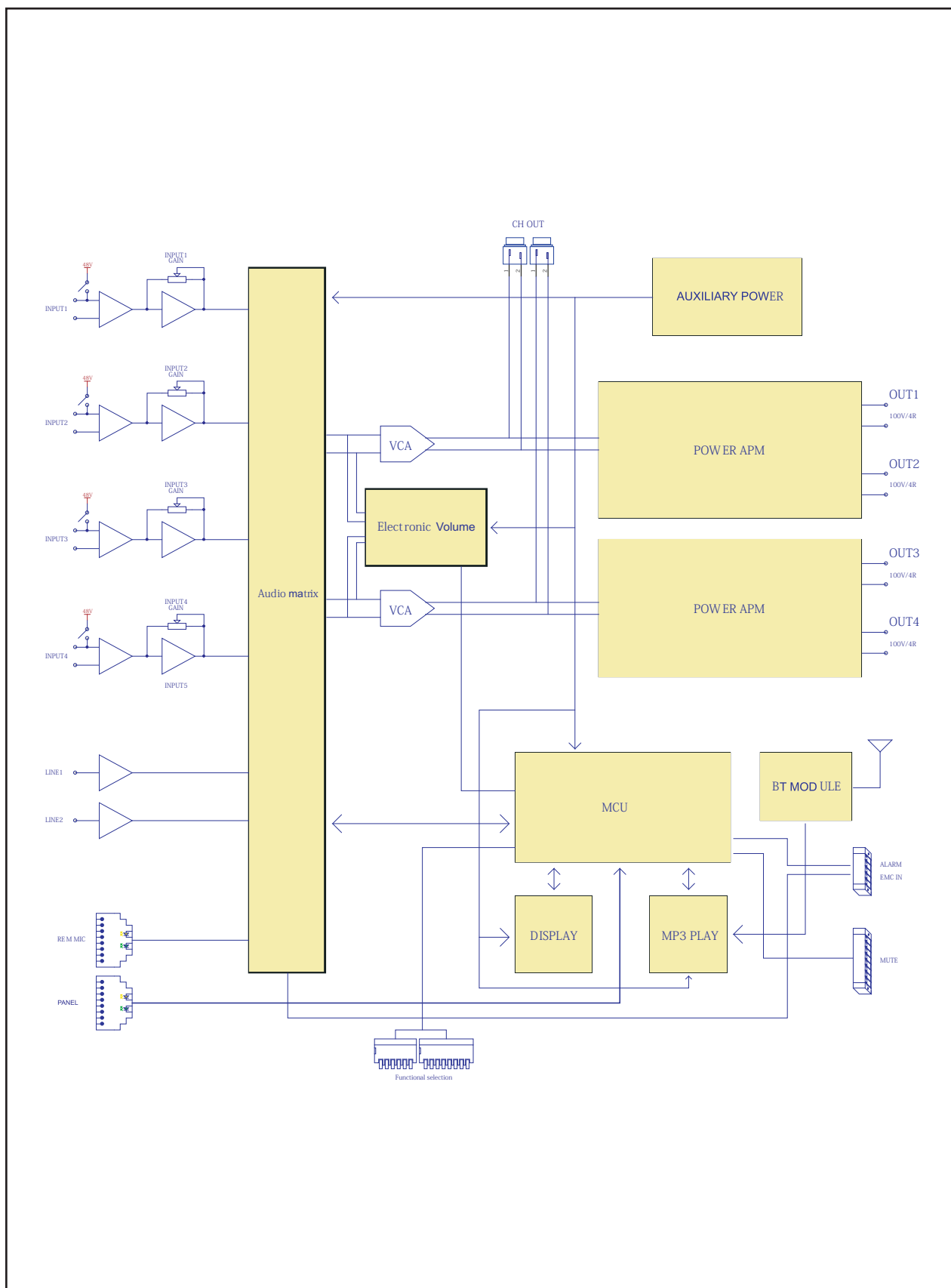

10. SPECIFICATIONS

Model	T-4120UC	T-4240UC
Output terminal	4×120W	4×240W
Output Power	4-16Ω/100V	
Input sensitivity & impedance	INPUT1-4 Input: 5mV-350mV±40mV/600Ω; LINE1-2 Input: 350mV±40mV/10KΩ, Unbalanced RCA connection terminal; EMC Input: 775mV/10KΩ, Unbalanced European connection terminal	
Output sensitivity & source impedance	CH1-4:1000mV/470Ω Unbalanced RCA connection terminal	
Tone	Bass:±10dB at 100Hz; Treble:±10dB at 10KHz	
Frequency response	80Hz-16KHz(+1dB,-3dB)	
S/N Ratio	INPUT1-4:66dB; LINE1-2:80dB	
Distortion	Less than 0.5% (at 1KHz, 1/3 rated power)	
Phantom power	48V (±2V)	
Protection	High temperature, overload, short circuit	
Cooling	Forced cooling by fan	
Storage temperature	-20°C~+70°C	
Relative humidity	<95% (No condensation)	
Power supply	<input type="checkbox"/> ~110V 50Hz <input type="checkbox"/> ~110V 60Hz <input type="checkbox"/> ~120V 50Hz <input type="checkbox"/> ~120V 60Hz <input type="checkbox"/> ~220V 50Hz <input type="checkbox"/> ~220V 60Hz <input type="checkbox"/> ~230V 50Hz <input type="checkbox"/> ~230V 60Hz <input type="checkbox"/> ~240V 50Hz <input type="checkbox"/> ~240V 60Hz	
Power consumption	650W	1200W
Weight	7.3Kg	7.6Kg
Size	484×395×88mm	

11. DIMENSIONAL DIAGRAM

UNIT:mm

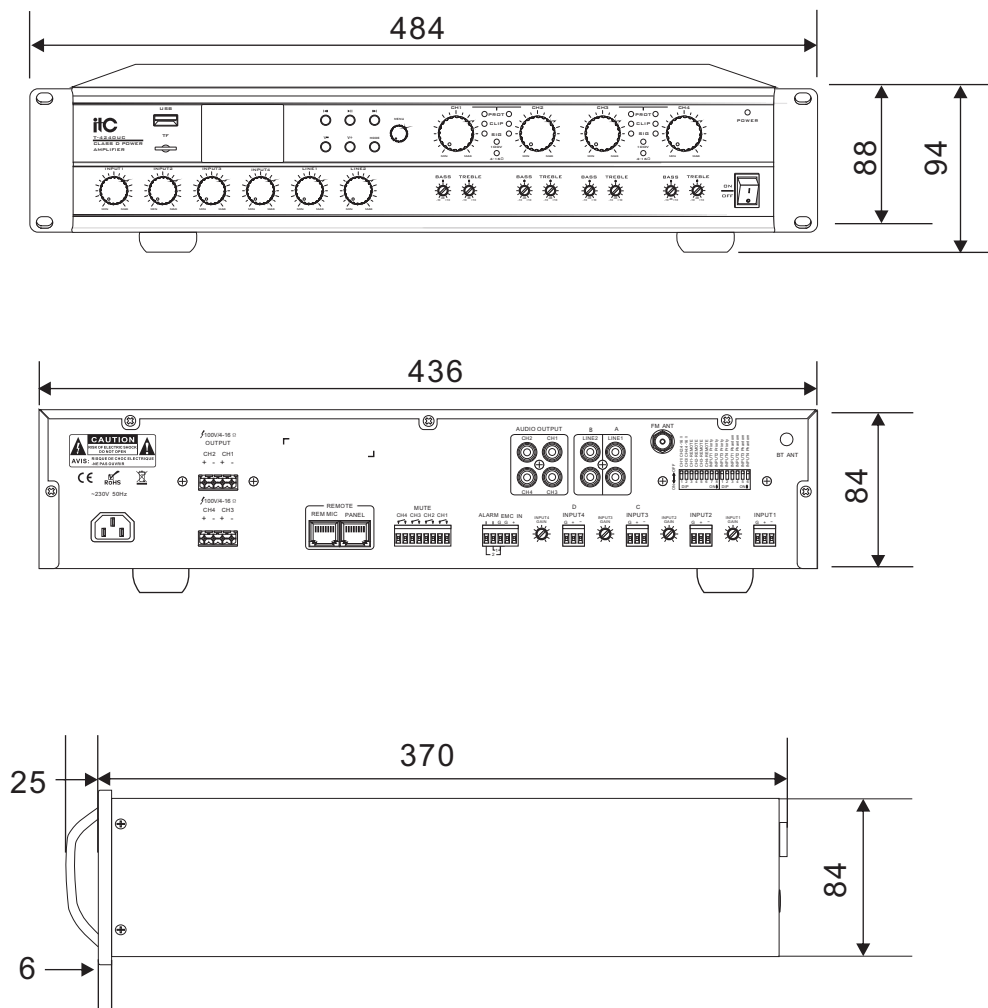

Keep the unit's all sides over 10 cm away from objects that may obstruct air flow to prevent the unit's internal temperature rise.

UNIT:mm

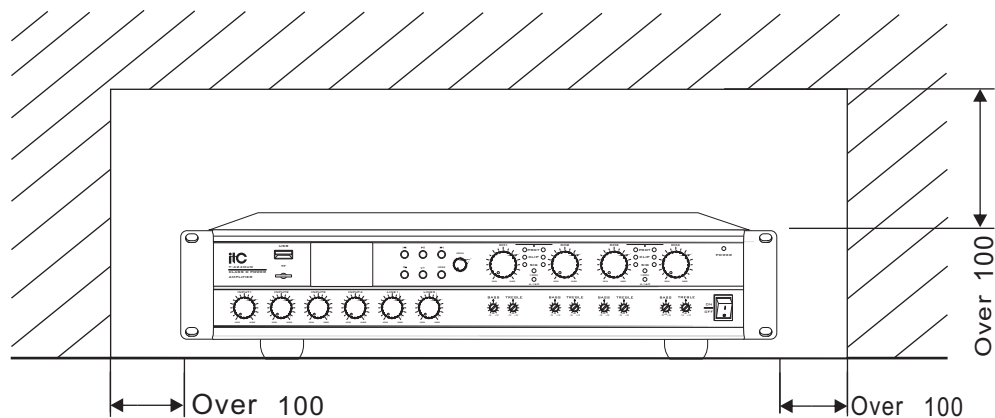

PUBLIC ADDRESS SYSTEM

