

# PJ-64/304

## Projection Speaker System

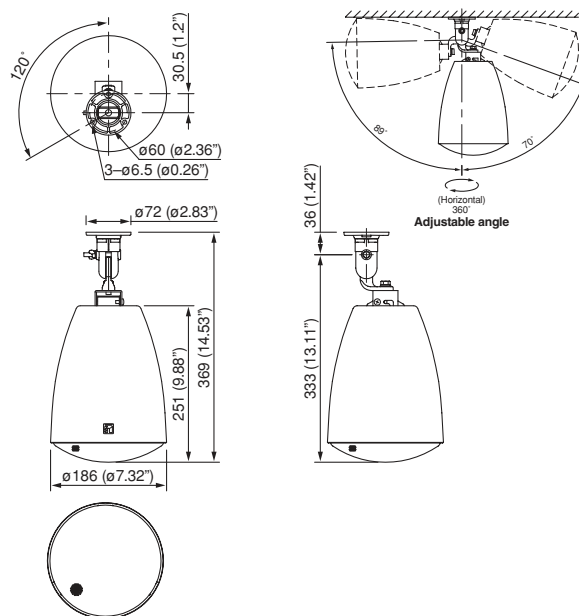

### APPEARANCE AND DIMENSIONAL DIAGRAM



### DESCRIPTION

The PJ-64/304 are bass-reflex HIPS resin enclosure 5" (12cm) cone-type projection speakers intended for ceiling and wall installation. The PJ-304 also includes a balanced dome tweeter. They have an outstandingly stylish design that is inspired by the finest lighting fixtures, allowing them to be harmoniously installed with lighting equipment. They are ideally suited for such applications as BGM and announcements at airports, subway stations, art museums and shopping malls. The speakers are easy to repaint, extending the range of design needs they can meet. A supplied swivel bracket accessory allows for flexible speaker angle adjustment. PJ-64 is driven on a high-impedance (100V or 70V) line, and PJ-304 is driven on a high- and low impedance (8Ω) line. Input impedance is adjustable with rotary switch on the upper side of the speaker.

### FEATURES

- Stylish and outstanding design inspired by the finest lighting fixtures
- Flexible speaker direction adjustment with accessory brackets
- Repaintable
- Input impedance easily changeable
- Ideally suited for BGM and announcements

### Wiring Diagram

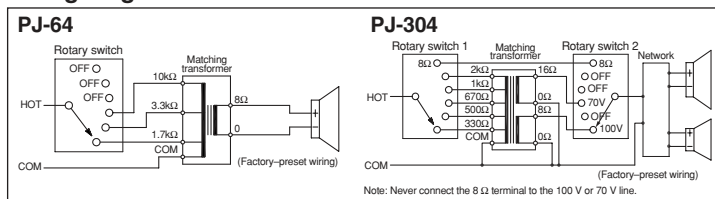

### SPECIFICATIONS

#### PJ-64

<b>Enclosure:</b>	Bass-reflex type
<b>Rated Input:</b>	6W (100V line), 3W (70V line)
<b>Rated Impedance:</b>	100V line: 1.7kΩ (6W), 3.3kΩ (3W), 10 kΩ (1W) 70V line: 1.7kΩ (3W), 3.3kΩ (1.5W), 10 kΩ (0.5W)
<b>Sensitivity (1W, 1m):</b>	90dB (500 – 5,000Hz, pink noise)
<b>Frequency Response:</b>	100 – 18,000Hz (peak –20dB)
<b>Speaker Component:</b>	5" (12cm) cone-type
<b>Speaker Cord:</b>	2-core cabtyre cord 60cm (1.97ft) with diameter of 6mm (0.24")
<b>Finish:</b>	Enclosure: HIPS resin, off-white (RAL 9010 or equivalent colour)/ Grille: Surface-treated steel plate net, off-white (RAL 9010 or equivalent colour), paint
<b>Dimensions:</b>	ø186 × 369(H) mm (ø7.32" × 14.33")
<b>Weight:</b>	1.5kg (3.31 lb) (unit only)
<b>Accessory:</b>	Swivel bracket × 1, Speaker mounting screw (4 × 16) × 3

#### PJ-304

<b>Enclosure:</b>	Bass-reflex type
<b>Rated Input:</b>	30W (100V, 70V line, 8Ω)
<b>Rated Impedance:</b>	100V line: 330Ω (30W), 500Ω (20W), 670Ω (15W), 1kΩ (10W), 2kΩ (5W) 70V line: 170Ω (30W), 250Ω (20W), 330Ω (15W), 500Ω (10W), 1 kΩ (5W) 8Ω (30W)
<b>Sensitivity (1W, 1m):</b>	91dB (500 – 5,000Hz, pink noise)
<b>Frequency Response:</b>	70 – 20,000Hz (peak –20dB)
<b>Speaker Component:</b>	5" (12cm) cone-type + balanced dome tweeter
<b>Speaker Cord:</b>	2-core cabtyre cord 60cm (1.97ft) with diameter of 6mm (0.24")
<b>Finish:</b>	Enclosure: HIPS resin, off-white (RAL 9010 or equivalent colour) Grille: Surface-treated steel plate net, off-white (RAL 9010 or equivalent colour), paint
<b>Dimensions:</b>	ø186 × 369(H) mm (ø7.32" × 14.33")
<b>Weight:</b>	2.1kg (4.63 lb) (unit only)
<b>Accessory:</b>	Swivel bracket × 1, Speaker mounting screw (4 × 16) × 3

**Polar Response**

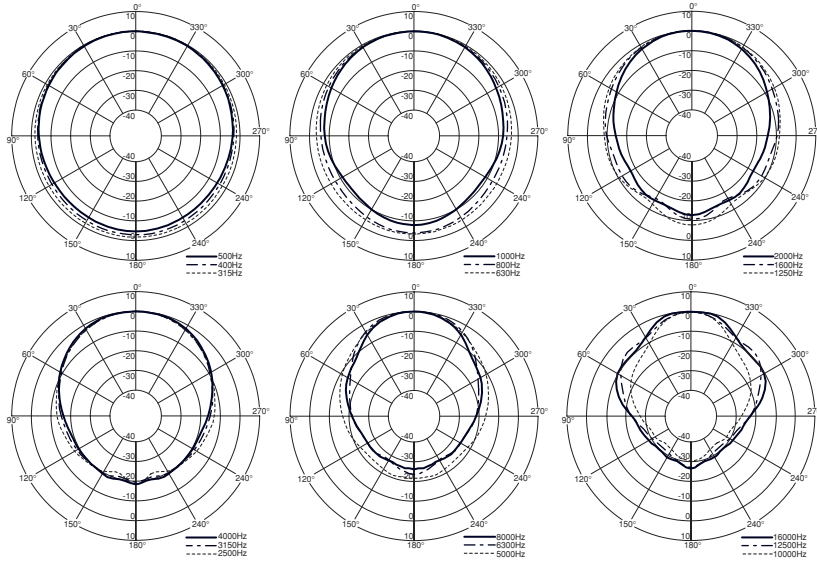

**SPL vs. Frequency**

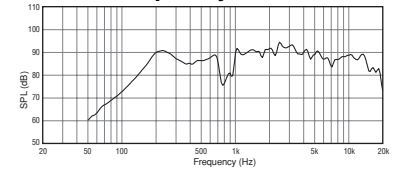

**Beamwidth vs. Frequency**

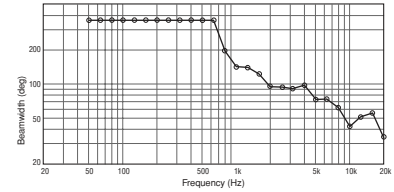

**Directivity Factor vs. Frequency**

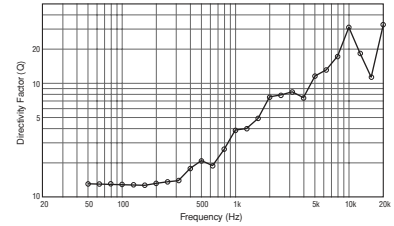

**PJ-304**

**Polar Response**

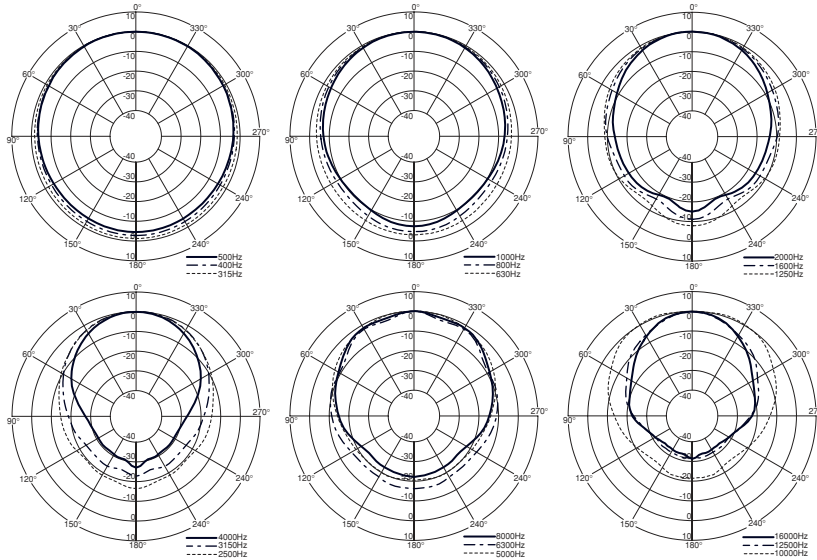

**SPL vs. Frequency**

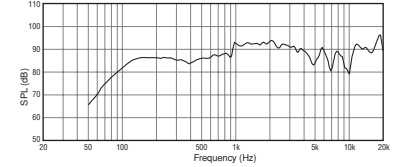

**Beamwidth vs. Frequency**

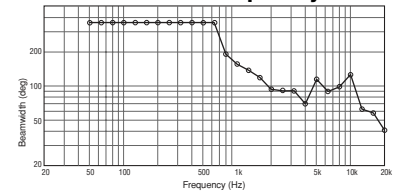

**Directivity Factor vs. Frequency**

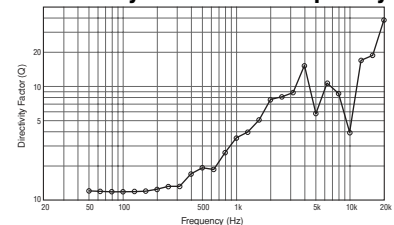

**Architect's and Engineer's Specifications**

**PJ-64**

The speaker shall be a bass-reflex 5" (12cm) cone type suitable for ceiling and wall mounting. Input impedance shall be easily adjustable with rotary switch on the upper side of the speaker.

The speaker shall include a transformer having multiple taps (1W, 3W, 6W at 100V and 0.5W, 1.5W, 3W at 70V) adjustable. The output sound pressure level at a distance of 1m with a 1W input level applied shall be 90 dB SPL. The speaker shall have a frequency response of 100 – 18,000Hz (-20dB).

The speaker enclosure shall be constructed of HIPS resin. The grille shall be constructed of surface-treated steel plate net. The speaker shall be available in off-white colour, and shall be easily repaintable. The unit shall have dimensions of  $\phi 186 \times 369$  (H) mm ( $\phi 7.32" \times 14.33"$ ), and a weight of 1.5 kg (3.31 lb).

The speaker shall be a TOA model PJ-64

**PJ-304**

The speaker shall be a bass-reflex 5" (12cm) cone type, with a balanced-dome tweeter, suitable for ceiling and wall mounting. Input impedance shall be easily adjustable with rotary switch on the upper side of the speaker.

The speaker shall include a transformer having multiple taps (5W, 10W, 15W, 20W, 30W at 100V and 70V, and 8 $\Omega$ ) adjustable. The output sound pressure level at a distance of 1m with a 1W input level applied shall be 91 dB SPL. The speaker shall have a frequency response of 70 – 20,000Hz (-20dB).

The speaker enclosure shall be constructed of HIPS resin. The grille shall be constructed of surface-treated steel plate net. The speaker shall be available in off-white colour, and shall be easily repaintable. The unit shall have dimensions of  $\phi 186 \times 369$  (H) mm ( $\phi 7.32" \times 14.33"$ ), and a weight of 2.1 kg (4.63 lb).

The speaker shall be a TOA model PJ-304.



TOA Corporation

www.toa.jp

Specifications are subject to change without notice. Printed in Japan (0708) 833-52-381-30 u