

Technical data sheet

Cap nut cable gland, PG thread, set with lock nut, light grey

Item no. 2024659



The quickest and most convenient way of providing strain relief and tightness with cable glands on junction boxes and housings is with the tried-and-trusted V-TEC VM cable glands from OBO. A protection rating of IP68 is achieved through the integrated sealing lip and the special OBO slat technology. Strain relief and tightness have been tested to DIN EN 62444.

The connection thread is a PG thread. Once screwed in place, the installation is there forever, as the optimum thread adjustment with the right pitch ensures permanent resistance to shaking.

Applications: From private housing with junction boxes up to industrial applications in the distributor cabinet.

Temperature range: -20 °C to +65 °C.



PA Polyamide

Additional product text 1

Table column D1: sealing range to VDE 0619, in which no strain relief is required.

Additional product text 2

Table column D2: Sealing range including strain relief and twist protection to VDE 0619

Master data

Item no.	2024659
Type	V-TEC PG11+ LGR
Description 1	Cable gland
Description 2	with locknut
Dimension	PG11
Colour	Light grey
RAL number	7035
Material	Polyamide
Material symbol	PA
Smallest sales unit (VG)	50,00 Piece
Weight	1,07 kg/100 pc.

Technical data sheet

Cap nut cable gland, PG thread, set with lock nut, light grey

Item no. 2024659



Technical data

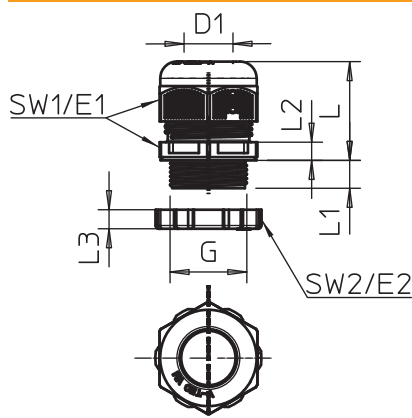

Dimension E1	25,00 mm
Dimension E2	24,00 mm
Dimension L min.	22,00 mm
Dimension L max.	29,00 mm
Dimension L1	8,00 mm
Dimension L2	5,00 mm
Dimension L3	5,00 mm
SW 1	22,00 mm
SW 2	24,00 mm
Version	Straight
Type of seal	Sealing ring
Bend protection	<input type="checkbox"/>
Sealing range D	3,50 - 10,00 mm
Sealing range D explosion-proof	0,20 - 0,39 in
Flat cable threaded connection	<input type="checkbox"/>
For Ex zone	Without
For Ex zone gas	Without
For Ex zone dust	Without
Thread	Pg 11
Thread type	PG
Thread length	8,00 mm
Thread increase	1,50 mm
Nominal thread size	11,00
Fibre-glass reinforced	<input type="checkbox"/>
Halogen-free	<input checked="" type="checkbox"/>
Multiple sealing insert	<input type="checkbox"/>
With locknut	<input checked="" type="checkbox"/>
Impact-resistant	<input type="checkbox"/>
Hexagonal corner dimension	25,00 mm
Protection rating	IP68
Splittable gland	<input type="checkbox"/>
max. permitted ambient temperature	-20,00 - 65,00 °C
Strain relief and wringing protection D2	4,50 - 10,00 mm
Strain relief option	<input checked="" type="checkbox"/>