

# USER MANUAL



## VOICE EVACUATION & PUBLIC ADDRESS SYSTEM

**VA-6200MA**

**VA-6200MS**

Thanks for using ITC Voice Evacuation & Public Address System.  
For better operation, please read this manual carefully before operating the system.

---

---

## Notification



To ensure the reliability of the equipment and the safety of personnel, please observe the following when installing, using and maintaining:

- If any of the following conditions are found, please immediately turn off the power, plug out and quickly contact your nearest dealer. Do not continue using this unit, which may cause a fire or electric shock.
  - If you find smoke or have a strange taste from the machine.
  - If water or metal falls into the machine.
  - If the unit is dropped or the case is damaged.
  - If the wire is damaged (wire core exposure, broken wire, etc.).
- If the machine contains high-pressure parts, in order to avoid the fire or electric shock, absolutely don't open the case, if any questions please inform your nearest dealer.
- Do not place cups, bowls, vases or metal and other water-filled substances on the unit. Serious spilled liquid may cause a fire or electric shock.
- Never expose the unit to rain and any moisture or water, which may cause electric shock or fire.
- Do not place metal objects or flammable materials from the vents on the machine cover, nor place coins, which may cause fire or electric shock.
- Do not place heavy objects on the unit to avoid personal injury or property damage when the unit is slipping.
- Make sure that the volume is turned on at the beginning of the boot, and the high volume of the boot may cause hearing problems.
- Make sure that the volume is turned on at the beginning of the boot, and the high volume of the boot may cause hearing problems.
- For long-term accumulation of dust to be cleaned, please inform your dealer to regularly clean the machine, so as to avoid damage to the machine or cause a fire.
- The battery must be replaced with the same type of product and the correct installation should be made in order to avoid electrical damage and explosion hazard.
- The product is a Class I device. The device must be well connected to ground. The power plug must be connected to a power outlet with a grounding device to ensure that the equipment is fully grounded.
- This product uses a power plug or appliance input socket as a disconnecting device with the power supply, and must be disconnected if necessary for safety reasons.



- This equipment is only suitable for safe use at altitudes under 2000 meters.

## Precautions

### 1. The installation environment

When installing the unit, in order to ensure the normal cooling of the host, should avoid the poor ventilation of the place or high temperature environment, to avoid direct sunlight.

Recommend to install cabinet or other well-ventilated place indoor. If you use the machine in the outdoors, please pay attention to waterproof, moisture, lightning protection measures.

Avoid installing in a violent place of vibration; do not place other equipment on the machine.

### 2. To avoid electric shock and fire

Do not touch the hands and the source with wet hands

Do not spill liquid on the machine, so as to avoid short-circuit or fire inside the machine.

Do not place other equipment directly on the top of the unit.

Non-professional service personnel Do not disassemble the unit yourself to avoid damage and electric shock.

### 3. Transport and handling

The packaging of the machine is designed and tested to ensure that the host will not be accidentally damaged during transport. It is best to use the original packaging when handling the unit.

Do not move the host device between the place or cold or over hot to avoid condensation inside the machine, affecting equipment life.

### 4. Please follow the warning instructions on this product, the warning signs on behalf of:

	Applicable to 2000 meters above sea level and below safe use
	Safe use only in non-tropical climates

---

## 5. Agreement

Please strictly follow the instructions in this manual. The software, hardware and appearance of this product will be upgraded and updated continually. The above changes will be made without notice.

Non-professional maintenance personnel, do not remove the product, to avoid damage and electric shock.

---

---

## Contents

1	Product renderings.....	6
1.1	VA-6200MA Product design sketch (2U) .....	6
1.2	VA-6200MS Product design sketch (2U) .....	6
2	Main function introduction.....	7
2.1	VA-6200MA Function feature.....	7
2.2	VA-6200MS Features.....	8
3	Main technical parameters Specifications.....	9
3.1	Electrical Specifications.....	9
3.2	Performance Specifications.....	9
4	Device function description.....	11
4.1	Front panel function description.....	11
4.2	Rear panel function description.....	13
5	Operation Instructions.....	15
5.1	Self-test function.....	15
5.2	Emergency function.....	15
5.3	Local sound source play.....	16
5.4	PTT paging.....	17
5.5	Line detection.....	17
5.6	Volume control.....	18
5.7	IP address Reset.....	19
5.8	Power-down switching function.....	19
5.9	Alarm voice replacement.....	20
5.10	Built-in MP3 player operation method.....	20
5.11	Voice Evacuation Router address Settings.....	21

# 1 Product renderings

## 1.1 VA-6200MA Product design sketch ( 2U )

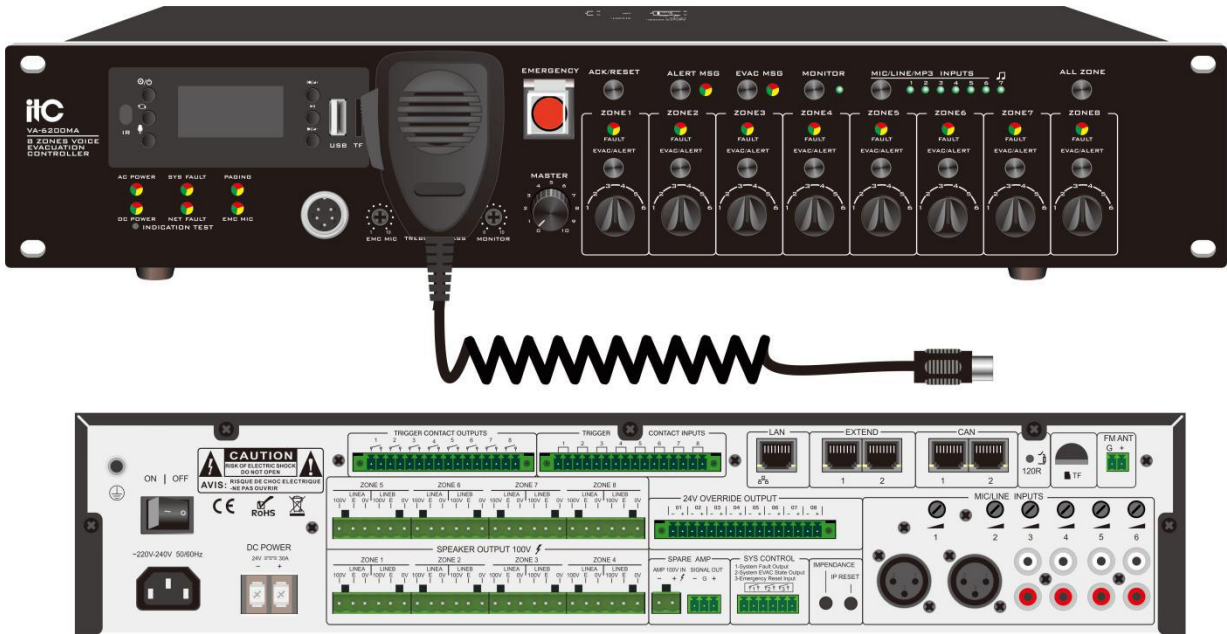

FIGURE 1-1 VA-6200MA Product renderings

## 1.2 VA-6200MS Product design sketch ( 2U )



FIGURE 1-2 VA-6200MS Product renderings

---

---

## 2 Main function introduction

### 2.1 VA-6200MA Function feature

- Built-in 500W amplifier, integrated 8 power A + B independent dual speaker loop partition output, each partition has a LED indicator, independent volume adjustment (6 files), forcibly cut to output power 100V when receive alarm signal.
- Partition output with three-wire, four-wire Strong cut regulation function.
- With amplifier monitoring function.
- With 4 audio input, 2 microphone input with 24V phantom power
- Built-in USB/ TF card/ radio, and the audio source can share to all receiving equipment in the system.
- Integrated independent EVAC voice information player. Voice files can be customized by users
- Built- in HD audio module, support to record real-time PPT voice during fire alarm.
- Support TCP / IP communication protocol, after connecting to internet, all equipment in the system can be operated in real time through PC client-side, and the state automatically synchronized.
- Extensible to more 19 Extension Controller and 28 remote microphones ( allow to change the priority level) and 4 Wall-mounted microphone.
- 2 channel of remote MIC online interface with 24 V power, using standard RJ-45 network port and CAT-5 network cable, achieving lone-distance transmission.
- Function of fault self-checking of the electrical system,and complete inspection of manual system.
- Measuring function of the status of each partition speaker loop(open circuit, short circuit, overcurrent, impedance change).
- With system failure, emergency dry node output, emergency reset dry node input.
- The real-time indication function of the system status.
- 8- ways short circuit/level trigger manner, 3-way different audio sources to configure the trigger response, output can be configured with arbitrary partition、 group and Short circuit contact combination.
- External connecting a backup power amplifier, when the built-in amplifier doesn't work, it will switch to the backup amplifier automatically.
- External 24V stand-by power supply, realizing continuous work without delay when power off.
- Built-in 24V automatic charging function
- With one way IP address reset port.

---

## 2.2 VA-6200MS Features

- Built-in 500W amplifier, integrated 8 power A + B independent dual speaker loop partition output, each partition has a LED indicator, independent volume adjustment (6 files), forcibly cut to output power 100V when receive alarm signal.
- Partition output with three-wire, four-wire Strong cut regulation function.
- With 4 audio input, 2 microphone input with 24V phantom power.
- Function of fault self-checking of the electrical system, and complete inspection of manual system.
- Measuring function of the status of each partition speaker loop (open circuit, short circuit, overcurrent, impedance change).
- The real-time indication function of the system status.
- 8- ways short circuit/level trigger manner, 3-way different audio sources to configure the trigger response, output can be configured with arbitrary partition、 group and Short circuit contact combination.
- External connecting a backup power amplifier, when the built-in amplifier doesn't work, it will switch to the backup amplifier automatically.
- External 24V stand-by power supply, realizing continuous work without delay when power off.
- Built-in 24V automatic charging function
- With one way IP address reset port.
- 6-bit address DIP switch, can set the extended address.



---

## 3 Main technical parameters Specifications

### 3.1 Electrical Specifications

① Power supply

- Voltage  $\sim 220\text{-}240\text{V} \pm 20\%$ , 50-60Hz
- Fuse Size 3.5A

② Stand-by electric source

- Voltage DC 24V  $\pm 20\%$ , 18A
- Fuse Size 30A

### 3.2 Performance Specifications

① Analog audio

✧ microphone input

- Sensitivity  $\pm 2.5\text{mV}$
- Frequency response 200Hz  $\sim 10\text{kHz}$
- Input impedance 1k $\Omega$
- Signal to noise ratio  $> 70\text{dB}$

✧ Unbalanced audio input

- Sensitivity of 350mV
- Frequency response 80Hz  $\sim 16\text{kHz}$
- Impedance 10k $\Omega$
- Signal to noise ratio  $> 70\text{dB}$

✧ Balanced line input

- Sensitivity  $\pm 385\text{mV}$
- Frequency response 80Hz  $\sim 16\text{kHz}$
- Input impedance 20k $\Omega$
- Signal to noise ratio  $> 70\text{dB}$

✧ Balance line output

- Amplitude  $\pm 385\text{mV}$
- Distortion  $< 0.1\%$ , 1KHz

- 
- Frequency response 80Hz ~ 16kHz
  - Output impedance 470Ω
  - Signal to noise ratio > 70dB

② Communication

✧ RS485 interface

- Backup equipment RS485 interface
- Support maximum baud rate of 38400bps
- Supports up to 19 Backup equipments

✧ CAN interface

- Remote MIC console CAN interface
- Baud rate of 38400bps
- Supports up to 32 remote MIC consoles

③ Trigger input

Short circuit mode: Short circuit

Level mode: Need to be connected externally 10K and 4.7K resistance

④ Mechanical indicators

- Size (L × W × H) : 484\*360\*88 mm (19 "wide, 2U)
- Net weight : 11.4 Kg
- Install : tabletop or 19-inch cabinet
- Color: black

⑤ Environmental requirements

- Operating temperature +5 °C ~ +40 °C
- Storage temperature -20 °C ~ +70 °C
- Relative temperature <95%

## 4 Device function description

The bellowed is front panel introduction for controller VA-6200MA ( For VA-6200MS detailed function, please refer to VA-6200MA as they are with same front panel printing ):







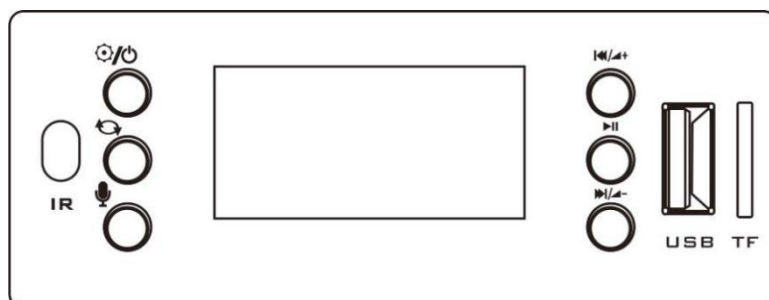

Figure 4-1 VA-6200MA front panel design sketch

### 4.1 Front panel function description

- Indicator and status description:
  - AC POWER: AC indicator, green on means normal , orange on means AC power off.
  - DC POWER: DC power indicator light, green on means 24V power connected , orange on means out of connect to DC 24V, light off means without configuration for DC power.
  - PAGING: remote control microphone indicator, green light means that the remote control microphone is paging the zone from the host.
  - SYS FAULT: orange indicates the host is faulty, flashing indicates that the host has a new fault.
  - NET FAULT: green means the network is normal, orange means the network is with failure.
  - EMC MIC: light off if well connected, green means PPT is paging, orange means PPT is with failure.
  
- MP3 independent play module function description:



The buttons function description as follows:

S.No	Buttons	Function
1		Mode function button; FM / USB / playing (Long press this button to forcibly turn on / off the machine)
2		Previous song (long press to increase volume)
3		Mp3 loop playback function button; (with Repeat One / Repeat ALL / Random / Repeat Folder mode.)
4		Play / Pause (long press this button in FM mode to receive the station)
5		No function button
6		Next song (long press to decrease volume)

- Volume potentiometer:
  - MONOROR: Monitor volume adjustment.
  - EMC MIC: PPT microphone volume adjustment.
  - TREBLE: Treble adjustment.
  - BASS:: Bass adjustment.
  
- EMERGENCY: emergency broadcast button, press to select ALERT MSG or EVAC MSG to broadcast emergency voice message, EVAC MSG is prior to ALERT MSG, then press EMERGENCY button, to close the broadcast.
- ACK/RESET: machine fault alarm reset button.
- ALERT MSG: Play emergency evacuation voice.
- EVAC MSG: Play fire alarm alert voice.
- MONITOR :buttons to switch on and off monitor.
- MIC / LINE INPUTS: button to select or switch the source.
- ALL ZONE: button to select open or close all zone.
- ZONE1~ZONE8:
  - Indicator: Indicates current zone status
    1. Orange: fault
    2. Green: normal
  - Zone switch button: switch on or off the zone .
  - Volume adjustment button: 6 grades volume adjustment knob.

## 4.2 Rear panel function description

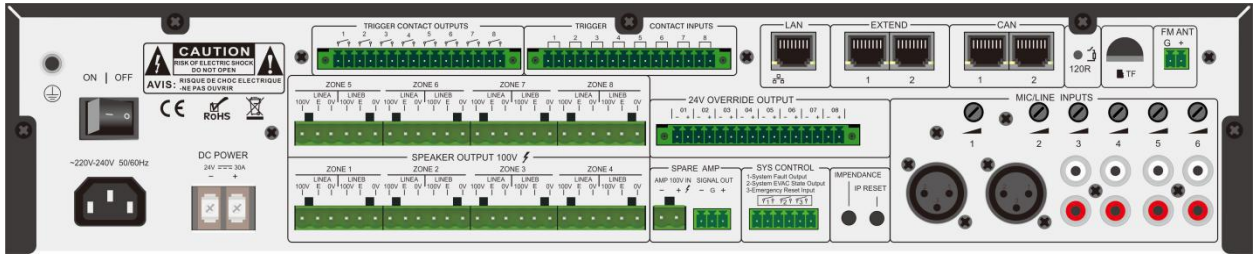

Figure 4-2 VA-6200MA rear panel design sketch

- ON for power on, OFF for power off.
  - AC power input socket.
  - DC POWER: 24V DC input interface, pay attention to positive and negative, Do not reverse!
  - 100V output interface, 24V relay control interface.
  - SPERKER OUTPUT 100V.
    - ZONE1 ~ 8
    - LINE A :zone A.
    - LINE B:zone B.
    - 100V: loudspeaker positive.
    - E: relay interface.
    - 0V: speaker negative.
  - TRIGGER CONTACT OUTPUTS: Short circuit signal output when fire alarm is triggered.
  - TRIGGER CONTACT ITPUTS: Fire trigger input interface.
  - 24V OVERRIDE OUTPUT: DC24V output interface for 4-wired volumn control.
  - SPARE AMP
    - AMP 100V IN: standby power amplifier 100V input interface (note positive and negative);
    - SIGANL OUT: signal output interface, access to the standby amplifier input port.
- Note: When using the standby power amplifier, you need adjust its volume to the appropriate position to ensure the amplifier is 100V output.
- SYS CONTRCL:
    - System Fault Output—When the system is running normally, the system fault output is turned off; after the fault and power is cut off, the system fault output is turned on.
    - System EVAC Output—When fire alarm is triggered, this port will output a short circuit signal.
    - Emergency Rest Input—when short-circuit signal is input, the fire alarm emergency status will be reset.

- 
- IMPEDANCE: The button of impedance Calibration, when it is pressed, the system will calibrate and record the current impedance automatically.
  - IP REST: The button to reset IP address, when it is press, the system will automatically reset the host IP address to the default value.
  - LAN: connection supports the TCP/IP protocol network interface
  - EXTEND: The port of connecting with slave devices.
  - CAN: The port of connecting with remote microphone interface.
  - TF: The TF card port.
  - FM ANT: The radio antenna interface.

Note:

- ① The standby amplifier must use digital amplifier , cannot use the analog amplifier.
- ② Cable requirements: CAT5E or above (wire diameter 0.49mm-0.51mm).

---

---

## 5 Operation Instructions

### 5.1 Self-test function

#### 1. Power-on self-test:

- ① Connect the electricity AC power supply.
- ② Turn the power switch to the ON position.
- ③ Can hear the relay beat sound when connect the electricity.
- ④ Panel indicator will show the current system status.

#### 2. Manual self-test:

- ① Press INDICATION TEST on the front panel.
- ② There are three colors on the panel----- green, red and yellow light in turn, other lights are turn on, monitor is turn on, the relay beats in turn to finish the system self-test.

### 5.2 Emergency function

#### 1. Emergency voice function

- 1) Manually press the EMERGENCY button, red light flashes;
- 2) Press alert msg button on host panel to play alert voice language information, the response is decided by the PC configuration. Turn on the zone need alert message and turn off the zone do not need alert message.It will remember the previous setting for next trigger.
- 3) Press the EVAC msg button on host panel to play EVAC Msg voice language information, the response is decided by the PC configuration. Turn on the zone need alert message and turn off the zone do not need alert message.It will remember the previous setting for next trigger.

#### 2. Trigger emergency function

- 1) Wiring diagram of short circuit mode:

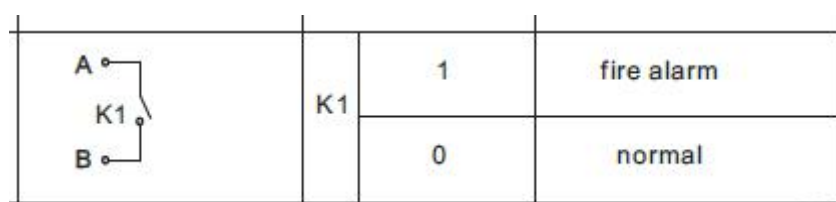

2) Wiring diagram of level trigger mode

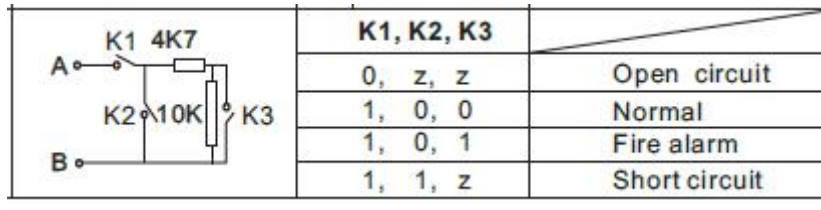

(Note: Dry contact trigger mode can be configured on the PC, can configure level trigger or LINE 3 as a sound source, after the emergency trigger can not restore the original play state.)

### 5.3 Local sound source play

■ Sound source selection

Source selection button

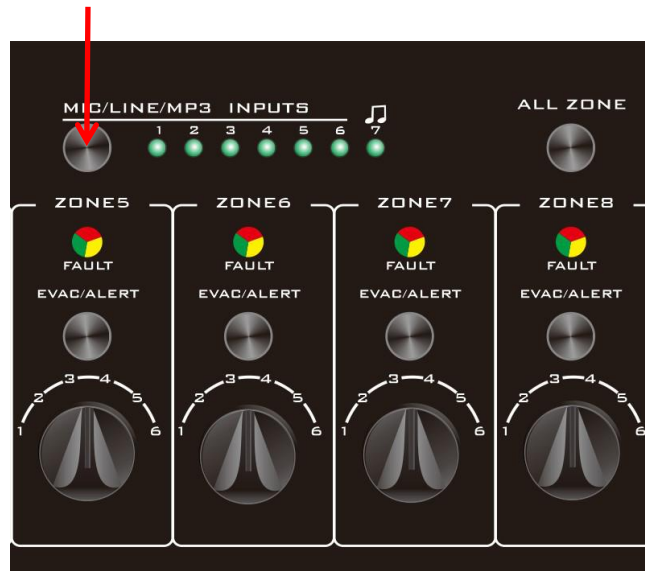

Press the key selection button to select the source channel. The corresponding indicator indicates the currently selected source. When LINE7 indicator turn on means select MP3.

1. Sound source play of each zone

a. The current selected audio source for MP3, turn on according zone can play MP3 sound source, press all zone button, all zones will play MP3. When you turn on the different zone, the zone status light is normally displayed in green.

b. When the current source is selected as background music, press zone 1 ~ 8 button to turn on or turn off current zone.

Through the MONITOR button to turn on or off the monitoring function, ensure monitor volume, main volume must be moderate, to ensure that at least one zone is turn.



---

## 5.4 PTT paging

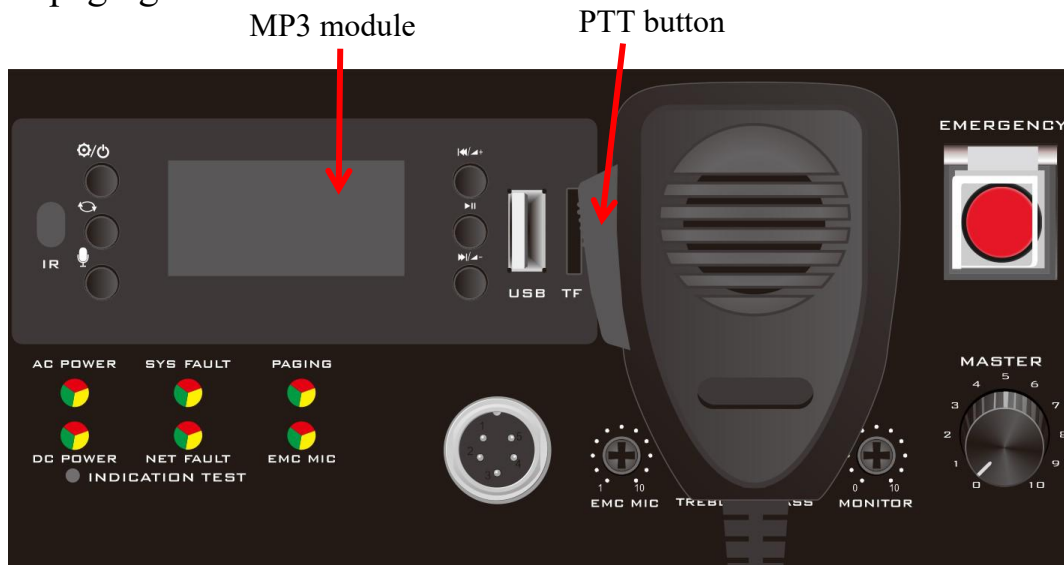

Press the EMERGENCY button, then press the button on the PTT microphone to turn on the corresponding zone paging (need configure on PC). You can speak after the reminder tone. Please do not release the button during the speaking or it will automatically turn off paging and make a tone. In emergency mode PTT paging will automatically record and save the audio in the TF card.

(Note: PTT has the highest priority in the system, but the host MP3 shared source is a separate module, not subject to its intervention.)

## 5.5 Line detection

Detection accuracy: <25%

Minimum detection power: 10W

Maximum detection power: 500W

Installation of the new device requires sampling the speaker impedance, the specific operation is as follows:

1. Install new equipment, connect speakers for each zone. When the wiring length is over 50 meters, the detection resistor (5W5K1J) needs to be connected to the end of the speaker line to improve the stability of the line detection.
2. Press impedance detection button on the rear panel, the system will be connected to each zone to sample the load, during sample period can hear during the relay inhalation of the sound, when the lights all off, indicating that the load sampling success.
3. Verify the impedance detection is valid or not:
  - 1) Open circuit detection ----- disconnect any zone output, press system fault self-test button in the front panel until the sound and light self-test is completed, the indicates

is orange and computer state is open (open) then connected to the speaker, press the self-test switch, and returned to normal state.

2) Short circuit test ----- Short circuit any zone output, do not need to press system fault self-test button on the front panel, Indicates light is orange and computer status short (short circuit). then connected to the speaker, press the self-test switch, and returned to normal state.

3) Impedance 25% change detection ----- sampling 30W speaker impedance, plus or minus 7W, press system fault self-test button on the front panel, the indicate light is orange and computer status is fault. Then connected to the 30W speaker, press the self-test switch, and returned to normal state.

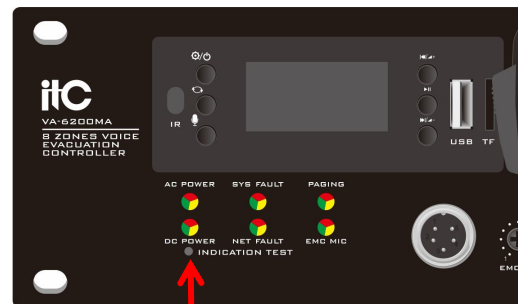

Impedance detection button

System fault self test button

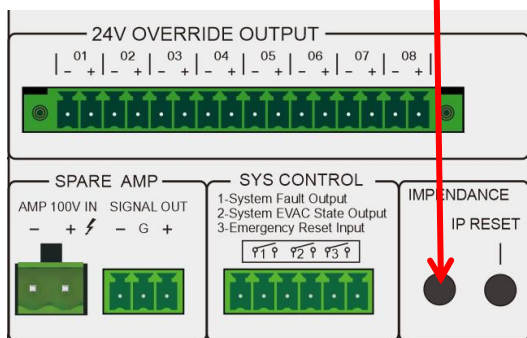

## 5.6 Volume control

PTT volume adjustment

Monitor volume adjustment

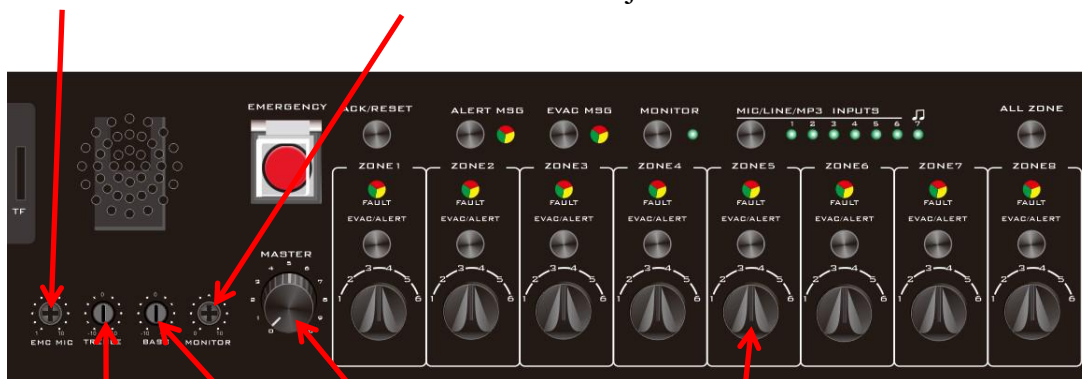

Host volume adjustment

Zone 1 ~ 8 volume adjustment

Treble adjustment Bass adjustment

1. Host volume control is control the volume of the entire machine, the adjustment will affect the 1 ~ 8 zone volume. Zone volume adjustment only adjusts the corresponding zone volume, does not affect other zones.

## 2. Amplifier output monitor

Press the MONITOR button to turn on or off the monitor, Light on means amplifier monitor is turn on, light off means amplifier monitor is turn off.

## 5.7 IP address Reset

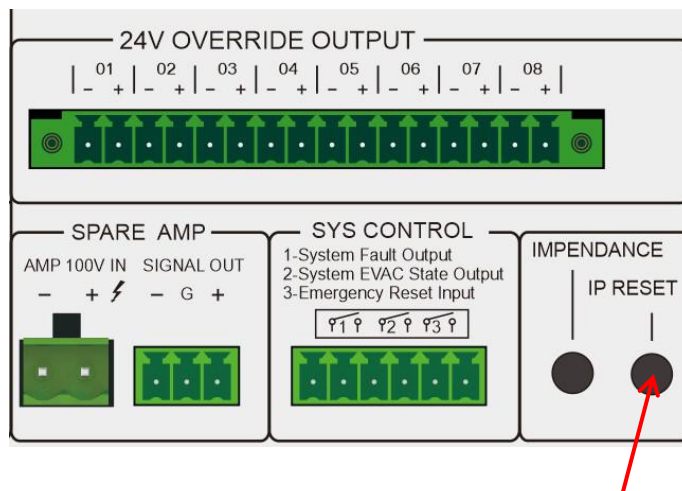

IP address Reset button

Press the IP reset button to reset the host IP address: 192.168.1.253.

## 5.8 Power-down switching function

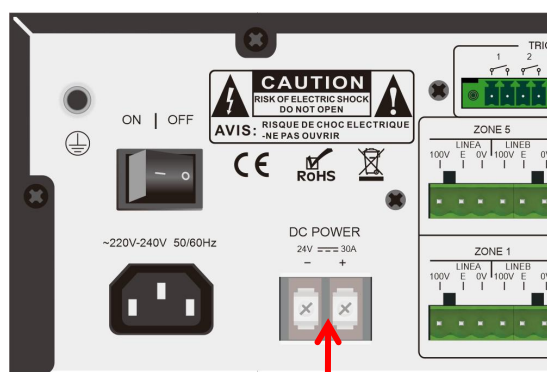

24V external power supply interface

Connect battery of 24V/30AH or above, 24V DC indicator light is green, when unplug AC electricity plug, automatically switch to 24V power supply mode.

---

## 5.9 Alarm voice replacement

1. Remove the TF card from the host and use a specialized card reader.
2. Plug in the computer, open the U disk, there are several folders.
3. Folder definition:
  - (1) ALERT: warning voice folder
  - (2) EVAC0: evacuation voice folder
  - (3) PROMT: prompt voice folder
  - (4) Other folders: ...
4. Put the voice file that needs to be replaced into the corresponding folder, delete the original voice file.

Note: The replaced voice file must be in .MP3 format, with a code rate  $\leq 192$ kbps, named after English characters.

## 5.10 Built-in MP3 player operation method

### USB function

Press the MODE button to select the USB mode, copy the MP3 file in the U disk (below 32G), and it supports MP3 / WAV / WMA / AEC / FLAC format.

### TF card function

Insert a TF card (below 32G) to copy the MP3 file, and it supports MP3 / WAV / WMA / AEC / FLAC format.

### FM (Radio reception) function

Press the MODE button to select the FM mode, and then long press the PLAY / PAUSE button to automatically receive the radio station. The radio stations received (depending on the sound received) depends on the venue.

### MP3 song loop playback

In USB or TF card mode, play a song at will, press the mode button to switch between REPEAT One / REPEAT ALL / Random / REPEAT Folder.

---

## Functional memory function

You can turn it off by the remote controller or long pressing the MODE button. After it is turned on, it can remember the function mode selected before. If you unplug the power cable and turn it on again, the default to keep the state when it was turned off last time.

## Volume +/-

Long press the Previous Song button to increase the volume quickly, and long press the Next Song button to decrease the volume quickly.

## 5.11 Voice Evacuation Router address Settings

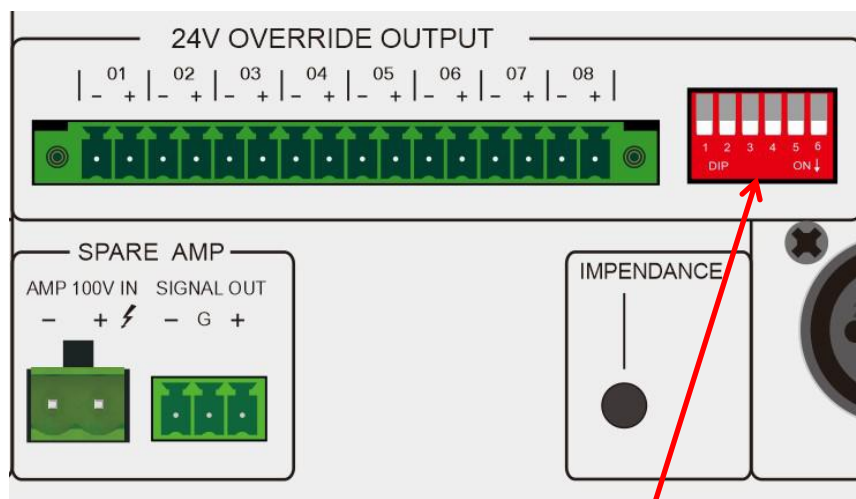

Extended host address switch

---

❖ **Voice Evacuation Router address Table:**

DIP Switch Settings								Voice Evacuation Controller Address
1	2	3	4	5	6	7	8	
1	0	0	0	0	0	0	0	1
0	1	0	0	0	0	0	0	2
1	1	0	0	0	0	0	0	3
0	0	1	0	0	0	0	0	4
1	0	1	0	0	0	0	0	5
0	1	1	0	0	0	0	0	6
1	1	1	0	0	0	0	0	7
0	0	0	1	0	0	0	0	8
1	0	0	1	0	0	0	0	9
0	1	0	1	0	0	0	0	10
1	1	0	1	0	0	0	0	11
0	0	1	1	0	0	0	0	12
1	0	1	1	0	0	0	0	13
0	1	1	1	0	0	0	0	14
1	1	1	1	0	0	0	0	15
0	0	0	0	1	0	0	0	16
1	0	0	0	1	0	0	0	17
0	1	0	0	1	0	0	0	18
1	1	0	0	1	0	0	0	19

**itC**

Version 0.5