

Readers

Indoor Mount speaker provides the public places with the background music, broadcast and fighting alarm. It is widely applicable for the restaurant, commercial mansion, factory, commercial districts, square, school, supermarket, snack bar etc.

Safety Tips

- Please be sure to use the former Reading detailed notes.
- Really pay attention to this manual and a safety with the important warning.
- Recommend that you keep this manual for future reference.

Common warning signs and security

The manual shown warning signs and security is to prevent the improper operation due to personal injury arising from the loss of property, please read before using this product must understand that this manual security symbols and Warning to indicate fully aware of potential risks.

 **Warning** Such as the inappropriate use of staff will cause injury, death and property damage.

When installed loudspeakers

- Restricted by the provisions of the speakers on the voltage, such as the use of high voltage may cause electric shock or fire disaster. Is no pruning, distorted, or replacement of damaged wires.
- Avoid instability in the installation or set up speakers, such as shaking the table or flat surface, The speaker can avoid falling caused personal injury or property damage.
- Speakers will be installed in support of the speaker or the weight of a solid shelf. Speaker swap can be avoided caused personal injury or property damage.
- Wet hands must not be admitted into or plugs, may lead to electric shocks.
- The allocation of plugs, make sure that pull plugs, rather than pull wires. the use of a damaged power line of machinery may cause fire or electric shock.
- Mobile speaker, you plug the prior allocated. If the speaker and plugs may be moving together will cause fire or electric shock. For plugs, identified as plugs for grip.
- Will not be allowed to speakers on the vent cover. May cause internal heating caused by the fire.
- Avoid speakers installed in the humidity or dust, direct contact with the sun, from the near-electric, or smoke or steam, may cause fire or electric shock.

itc

Garden Speaker



T-1900A

OWNER'S MANUAL

Dimension

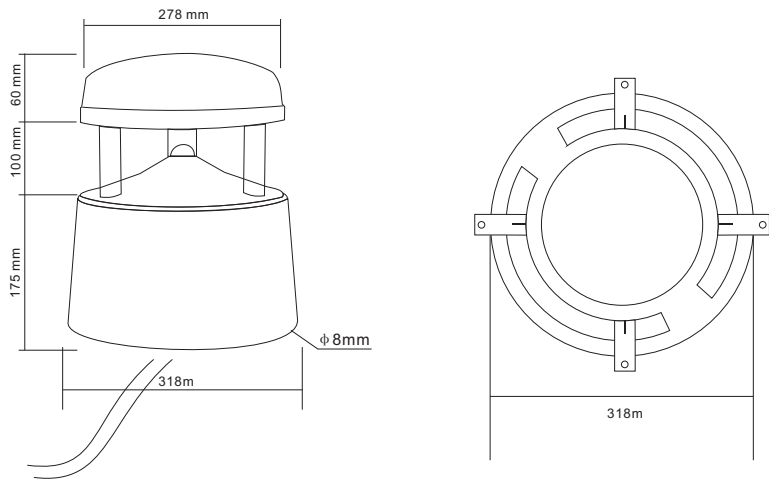

Specifications

Model	T-1900A
Power Taps@100V	12.5W,25W
Power Taps@70V	6.3W,12.5W
Impedance	Yellow/Green:COM,Brown:400 Ω ,Blue:800 Ω
Sensitivity	90dB
Max SPL	104dB
Freq resp	100Hz-14KHz
Mounting(mm)	
Dim(mm)	318X318X335
N.W	3.8Kg

Installation

1. Find a piece of hard grass; size: 318X318X335mm

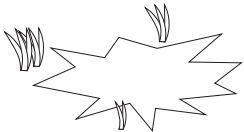

2. Install the 4 iron pieces in the 4 holes at the bottom of the corresponding speaker, And tighten the screws.

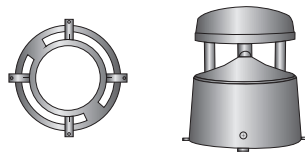

3. Gently place the Garden Speaker on the ground, Adjust and align the screw holes and lock them with screws Garden Speaker;

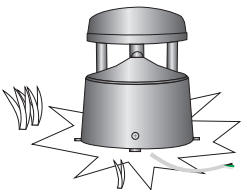

4. Parallel connection lines to complete the installation of Garden Speaker

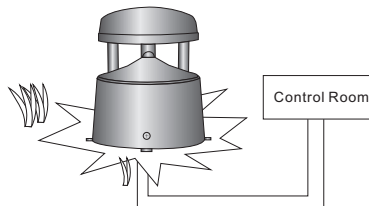

Labels stickers

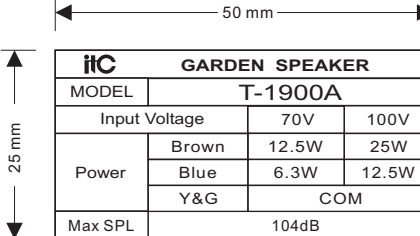

itC GARDEN SPEAKER			
MODEL	T-1900A		
Input Voltage	70V	100V	
Power	Brown	12.5W	25W
	Blue	6.3W	12.5W
	Y&G	COM	
Max SPL	104dB		