

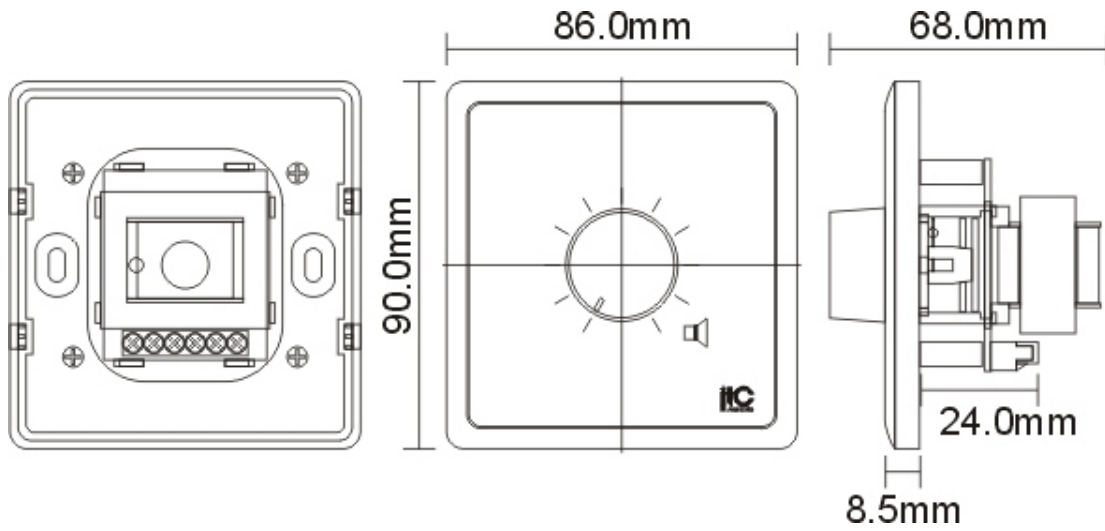

Specifications

Model	T-671
Input Power	6W
Control Mode	Transformer
Signal Input	70~100V
Signal Output	0~100V
Speaker Type	Voltage Speaker
Frequency Response	80-16KHz
Relay	/
Step	11 Steps
Finish	ABS, white
Mounting Size	86x86x50mm
Dimension	86x90x68mm
Weight	0.14Kg
Accessory	One pair screw of M3.5x2.0



Connections

